

# FAUST Quick Reference

(version 0.9.46)

GRAMME  
Centre National de Création Musicale

January 2012



# Contents

<b>1</b>	<b>Introduction</b>	<b>7</b>
1.1	Design Principles . . . . .	7
1.2	Signal Processor Semantic . . . . .	8
<b>2</b>	<b>Compiling and installing FAUST</b>	<b>9</b>
2.1	Organization of the distribution . . . . .	9
2.2	Compilation . . . . .	9
2.3	Installation . . . . .	10
2.4	Compilation of the examples . . . . .	10
<b>3</b>	<b>FAUST syntax</b>	<b>11</b>
3.1	FAUST program . . . . .	12
3.2	Statements . . . . .	12
3.2.1	Declarations . . . . .	12
3.2.2	Imports . . . . .	13
3.2.3	Documentation . . . . .	13
3.3	Definitions . . . . .	15
3.3.1	Simple Definitions . . . . .	15
3.3.2	Function Definitions . . . . .	16
3.3.3	Definitions with pattern matching . . . . .	16
3.4	Expressions . . . . .	17
3.4.1	Diagram Expressions . . . . .	17
3.4.2	Numerical Expressions . . . . .	22
3.4.3	Time expressions . . . . .	23
3.4.4	Environment expressions . . . . .	24
3.4.5	Foreign expressions . . . . .	27

3.4.6	Applications and Abstractions . . . . .	29
3.5	Primitives . . . . .	31
3.5.1	Numbers . . . . .	31
3.5.2	C-equivalent primitives . . . . .	32
3.5.3	math.h-equivalent primitives . . . . .	33
3.5.4	Delay, Table, Selector primitives . . . . .	34
3.5.5	User Interface Elements . . . . .	34
<b>4</b>	<b>Invoking the FAUST compiler</b>	<b>41</b>
4.1	Compilation options . . . . .	41
<b>5</b>	<b>Architecture files</b>	<b>45</b>
5.1	Audio architecture modules . . . . .	45
5.2	UI architecture modules . . . . .	47
5.2.1	Active widgets . . . . .	47
5.2.2	Passive widgets . . . . .	49
5.2.3	Widgets layout . . . . .	49
5.2.4	Metadata . . . . .	49
5.3	OSC architecture modules . . . . .	49
5.3.1	OSC GUI architecture module . . . . .	50
5.3.2	OSC message aliases . . . . .	51
5.3.3	OSC audio architecture . . . . .	53
<b>6</b>	<b>Controlling the code generation</b>	<b>55</b>
6.1	Vector Code generation . . . . .	55
6.2	Parallel Code generation . . . . .	57
6.2.1	The OpenMP code generator . . . . .	57
6.2.2	Adding OpenMP directives . . . . .	59
6.2.3	Example of parallel OpenMP code . . . . .	61
6.2.4	The scheduler code generator . . . . .	63
6.2.5	Example of parallel scheduler code . . . . .	63
<b>7</b>	<b>Mathematical Documentation</b>	<b>67</b>
7.1	Goals of the mathdoc . . . . .	67
7.2	Installation requirements . . . . .	67
7.3	Generating the mathdoc . . . . .	68
7.3.1	Invoking the -mdoc option . . . . .	68
7.3.2	Invoking faust2mathdoc . . . . .	68
7.3.3	Online examples . . . . .	69

<i>CONTENTS</i>	5
7.4 Automatic documentation . . . . .	69
7.5 Manual documentation . . . . .	69
7.5.1 Six tags . . . . .	69
7.5.2 The mdoc top-level tags . . . . .	70
7.5.3 An example of manual mathdoc . . . . .	70
7.5.4 The -stripmdoc option . . . . .	72
7.6 Localization of mathdoc files . . . . .	72
7.7 Summary of the mathdoc generation steps . . . . .	76
<b>8 Acknowledgments</b>	<b>77</b>



# Chapter 1

## Introduction

FAUST (*Functional Audio Stream*) is a functional programming language specifically designed for real-time signal processing and synthesis. FAUST targets high-performance signal processing applications and audio plug-ins for a variety of platforms and standards.

### 1.1 Design Principles

Various principles have guided the design of FAUST:

- FAUST is a *specification language*. It aims at providing an adequate notation to describe *signal processors* from a mathematical point of view. FAUST is, as much as possible, free from implementation details.
- FAUST programs are fully compiled, not interpreted. The compiler translates FAUST programs into equivalent C++ programs taking care of generating the most efficient code. The result can generally compete with, and sometimes even outperform, C++ code written by seasoned programmers.
- The generated code works at the sample level. It is therefore suited to implement low-level DSP functions like recursive filters. Moreover the code can be easily embedded. It is self-contained and doesn't depend of any DSP library or runtime system. It has a very deterministic behavior and a constant memory footprint.
- The semantic of FAUST is simple and well defined. This is not just of academic interest. It allows the FAUST compiler to be *semantically driven*. Instead of compiling a program literally, it compiles the mathematical function it denotes. This feature is useful for example to promote components reuse while preserving optimal performance.
- FAUST is a textual language but nevertheless block-diagram oriented. It actually combines two approaches: *functional programming* and *algebraic block-diagrams*. The key idea is to view block-diagram construction as function composition. For that purpose, FAUST relies on a *block-diagram algebra* of five composition operations (`:`, `~`, `<:`, `:>`).

- Thanks to the notion of *architecture*, FAUST programs can be easily deployed on a large variety of audio platforms and plugin formats without any change to the FAUST code.

## 1.2 Signal Processor Semantic

A FAUST program describes a *signal processor*. The role of a *signal processor* is to transform a group of (possibly empty) *input signals* in order to produce a group of (possibly empty) *output signals*. Most audio equipments can be modeled as *signal processors*. They have audio inputs, audio outputs as well as control signals interfaced with sliders, knobs, vu-meters, etc.

More precisely :

- A *signal*  $s$  is a discrete function of time  $s : \mathbb{N} \rightarrow \mathbb{R}$ . The value of signal  $s$  at time  $t$  is written  $s(t)$ . The set  $\mathbb{S} = \mathbb{N} \rightarrow \mathbb{R}$  is the set of all possible signals.
- A group of  $n$  signals (a  $n$ -tuple of signals) is written  $(s_1, \dots, s_n) \in \mathbb{S}^n$ . The *empty tuple*, single element of  $\mathbb{S}^0$  is notated  $()$ .
- A *signal processors*  $p$ , is a function from  $n$ -tuples of signals to  $m$ -tuples of signals  $p : \mathbb{S}^n \rightarrow \mathbb{S}^m$ . The set  $\mathbb{P} = \bigcup_{n,m} \mathbb{S}^n \rightarrow \mathbb{S}^m$  is the set of all possible signal processors.

FAUST considers two type of signals: *integer signals* ( $s : \mathbb{N} \rightarrow \mathbb{Z}$ ) and *floating point signals* ( $s : \mathbb{N} \rightarrow \mathbb{Q}$ ). Exchanges with the outside world are, by convention, made using floating point signals. The full range is represented by sample values between -1.0 and +1.0.

As an example, let's express the semantic of the FAUST primitive  $+$ . Like any FAUST expression, it is a signal processor. Its signature is  $\mathbb{S}^2 \rightarrow \mathbb{S}$ . It takes two input signals  $X_0$  and  $X_1$  and produce an output signal  $Y$  such that  $Y(t) = X_0(t) + X_1(t)$ .

Numbers are signal processors too. For example the number 3 has signature  $\mathbb{S}^0 \rightarrow \mathbb{S}$ . It takes no input signals and produce an output signal  $Y$  such that  $Y(t) = 3$ .



## Chapter 2

# Compiling and installing FAUST

The FAUST source distribution `faust-0.9.46.tar.gz` can be downloaded from sourceforge (<http://sourceforge.net/projects/faudiostream/>).

### 2.1 Organization of the distribution

The first thing is to decompress the downloaded archive.

```
tar xzf faust-0.9.46.tar.gz
```

The resulting `faust-0.9.46/` folder should contain the following elements:

<code>architecture/</code>	FAUST libraries and architecture files
<code>benchmark</code>	tools to measure the efficiency of the generated code
<code>compiler/</code>	sources of the FAUST compiler
<code>examples/</code>	examples of FAUST programs
<code>syntax-highlighting/</code>	support for syntax highlighting for several editors
<code>documentation/</code>	FAUST's documentation, including this manual
<code>tools/</code>	tools to produce audio applications and plugins
<code>COPYING</code>	license information
<code>Makefile</code>	Makefile used to build and install FAUST
<code>README</code>	instructions on how to build and install FAUST

### 2.2 Compilation

FAUST has no dependencies outside standard libraries. Therefore the compilation should be straightforward. There is no configuration phase, to compile the FAUST compiler simply do :

```
cd faust-0.9.46/  
make
```

If the compilation was successful you can test the compiler before installing it:

```
[cd faust-0.9.46/]
./compiler/faust -v
```

It should output:

```
FAUST, DSP to C++ compiler, Version 0.9.46
Copyright (C) 2002-2012, GRAME - Centre...
```

Then you can also try to compile one of the examples :

```
[cd faust-0.9.46/]
./compiler/faust examples/noise.dsp
```

It should produce some C++ code on the standard output

## 2.3 Installation

You can install FAUST with:

```
[cd faust-0.9.46/]
sudo make install
```

or

```
[cd faust-0.9.46/]
su
make install
```

depending on your system.

## 2.4 Compilation of the examples

Once FAUST correctly installed, you can have a look at the provided examples in the `examples/` folder. This folder contains a `Makefile` with all the required instructions to build these examples for various *architectures*, either standalone audio applications or plugins.

The command `make help` will list the available targets. Before using a specific target, make sure you have the appropriate development tools, libraries and headers installed. For example to compile the examples as ALSA applications with a GTK user interface do a `make alsagtk`. This will create a `alsagtkdir/` subfolder with all the binaries.

An architecture file provides the code needed to connect a signal processor to the outside world. It typically defines the audio communications and user interface.

## Chapter 3

# FAUST syntax

This section describes the syntax of FAUST. Figure 3.1 gives an overview of the various concepts and where they are defined in this section.

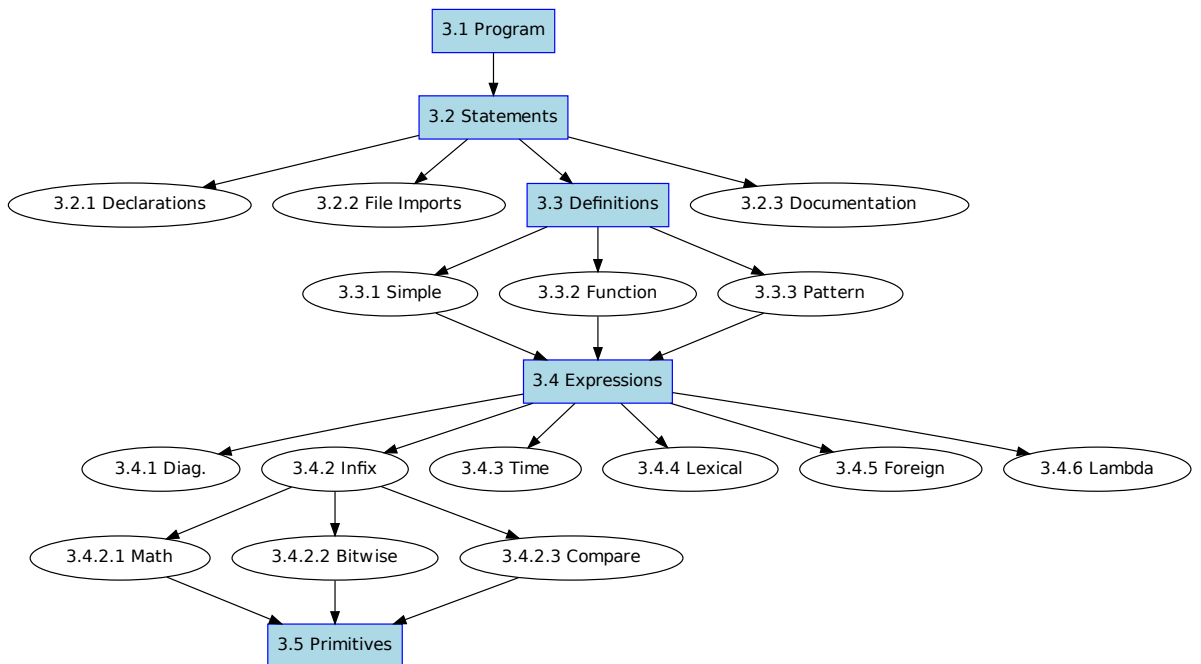

Figure 3.1: Overview of FAUST syntax

As we will see, *definitions* and *expressions* have a central role.

## 3.1 FAUST program

A FAUST program is essentially a list of *statements*. These statements can be *declarations*, *imports*, *definitions* and *documentation tags*, with optional C++ style (`//...` and `/*...*/`) comments.

*program*

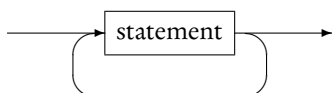

Here is a short FAUST program that implements of a simple noise generator. It exhibits various kind of statements : two *declarations*, an *import*, a *comment* and a *definition*. We will see later on *documentation* statements (3.2.3).

```
declare name      "noise";
declare copyright "(c)GRAME 2006";

import("music.lib");

// noise level controlled by a slider
process = noise * vslider("volume", 0, 0, 1, 0.1);
```

The keyword `process` is the equivalent of `main` in C/C++. Any FAUST program, to be valid, must at least define `process`.

## 3.2 Statements

The *statements* of a FAUST program are of four kinds : *metadata declarations*, *file imports*, *definitions* and *documentation*. All statements but *documentation* end with a semicolon (;).

*statement*

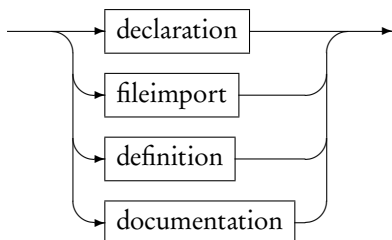

### 3.2.1 Declarations

Meta-data declarations (for example `declare name "noise";`) are optional and typically used to document a FAUST project.

*declaration*

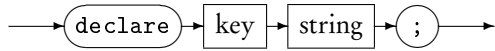

*key*

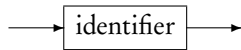

Contrary to regular comments, these declarations will appear in the C++ code generated by the compiler. A good practice is to start a FAUST program with some standard declarations:

```

declare name "MyProgram";
declare author "MySelf";
declare copyright "MyCompany";
declare version "1.00";
declare license "BSD";
  
```

### 3.2.2 Imports

File imports allow to import definitions from other source files.

*fileimport*

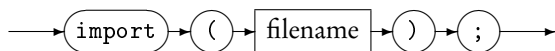

For example `import("math.lib");` imports the definitions of the `math.lib` library, a set of additional mathematical functions provided as foreign functions.

### 3.2.3 Documentation

Documentation statements are optional and typically used to control the generation of the mathematical documentation of a FAUST program. This documentation system is detailed chapter 7. In this section we will essentially describe the documentation statements syntax.

A documentation statement starts with an opening `<mdoc>` tag and ends with a closing `</mdoc>` tag. Free text content, typically in  $\text{\LaTeX}$  format, can be placed in between these two tags.

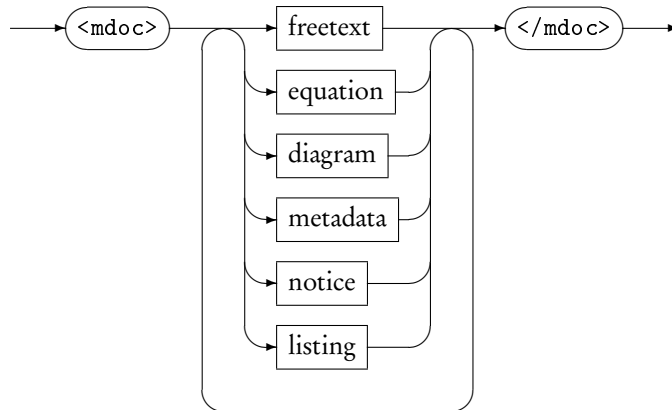
*documentation*

Moreover, optional sub-tags can be inserted in the text content itself to require the generation, at the insertion point, of mathematical *equations*, graphical *block-diagrams*, FAUST source code *listing* and explanation *notice*.

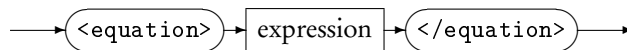
*equation*

The generation of the mathematical equations of a FAUST expression can be requested by placing this expression between an opening `<equation>` and a closing `</equation>` tag. The expression is evaluated within the lexical context of the FAUST program.

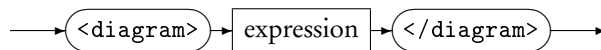
*diagram*

Similarly, the generation of the graphical block-diagram of a FAUST expression can be requested by placing this expression between an opening `<diagram>` and a closing `</diagram>` tag. The expression is evaluated within the lexical context of the FAUST program.

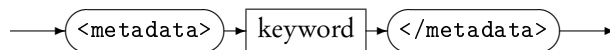
*metadata*

The `<metadata>` tags allow to reference FAUST metadatas (cf. declarations), calling the corresponding keyword.

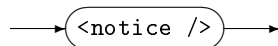
*notice*

The `<notice />` empty-element tag is used to generate the conventions used in the mathematical equations.

*listing*

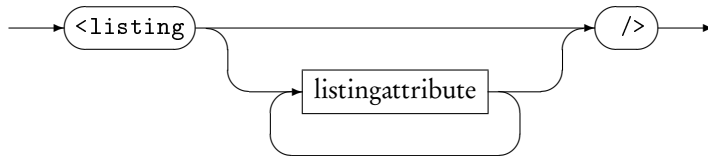

*listingattribute*

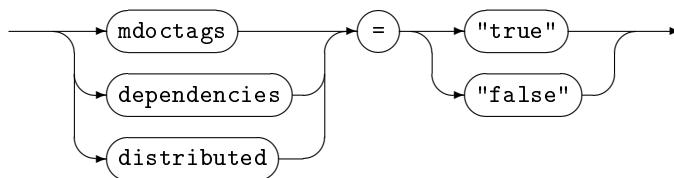

The `<listing />` empty-element tag is used to generate the listing of the FAUST program. Its three attributes `mdoctags`, `dependencies` and `distributed` enable or disable respectively `<mdoc>` tags, other files dependencies and distribution of interleaved faust code between `<mdoc>` sections.

## 3.3 Definitions

A *definition* associates an identifier with an expression it stands for.

Definitions are essentially a convenient shortcut avoiding to type long expressions. During compilation, more precisely during the evaluation stage, identifiers are replaced by their definitions. It is therefore always equivalent to use an identifier or directly its definition. Please note that multiple definitions of a same identifier are not allowed, unless it is a pattern matching based definition.

### 3.3.1 Simple Definitions

The syntax of a simple definition is:

*definition*

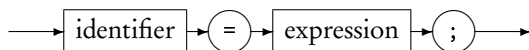

For example here is the definition of `random`, a simple pseudo-random number generator:

```
random = +(12345) ~ *(1103515245);
```

### 3.3.2 Function Definitions

Definitions with formal parameters correspond to functions definitions.

*definition*

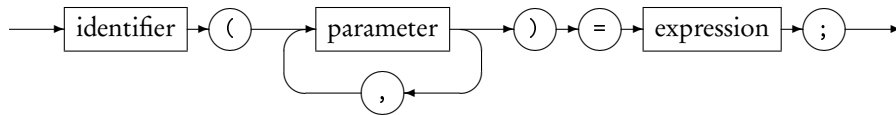

For example the definition of `linear2db`, a function that converts linear values to decibels, is :

```
linear2db(x) = 20*log10(x);
```

Please note that this notation is only a convenient alternative to the direct use of *lambda-abstractions* (also called anonymous functions). The following is an equivalent definition of `linear2db` using a lambda-abstraction:

```
linear2db = \ (x) . (20*log10(x));
```

### 3.3.3 Definitions with pattern matching

Moreover, formal parameters can also be full expressions representing patterns.

*definition*

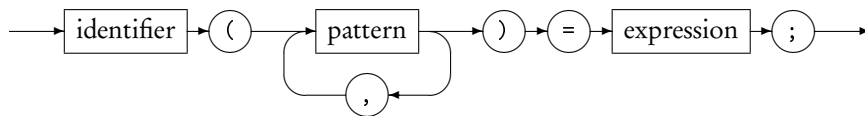

*pattern*

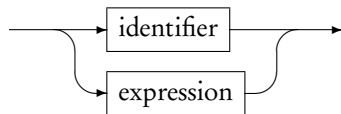

This powerful mechanism allows to algorithmically create and manipulate block diagrams expressions. Let's say that you want to describe a function to duplicate an expression several times in parallel:

```
duplicate(1, x) = x;
duplicate(n, x) = x, duplicate(n-1, x);
```

Please note that this last definition is a convenient alternative to the more verbose :

```
duplicate = case {
    (1, x) => x;
    (n, x) => duplicate(n-1, x);
};
```



Here is another example to count the number of elements of a list. Please note that we simulate lists using parallel composition : (1,2,3,5,7,11). The main limitation of this approach is that there is no empty list. Moreover lists of only one element are represented by this element :

```
count((x, xs)) = 1+count(xs);
count(x) = 1;
```

If we now write `count(duplicate(10,666))` the expression will be evaluated to 10. Please note that the order of pattern matching rules matters. The more specific rules must precede the more general rules. When this order is not respected, as in :

```
count(x) = 1;
count((x, xs)) = 1+count(xs);
```

the first rule will always match and the second rule will never be called.

## 3.4 Expressions

Despite its textual syntax, FAUST is conceptually a block-diagram language. FAUST expressions represent DSP block-diagrams and are assembled from primitive ones using various *composition* operations. More traditional *numerical* expressions in infix notation are also possible. Additionally FAUST provides time based expressions, like delays, expressions related to lexical environments, expressions to interface with foreign function and lambda expressions.

*expression*

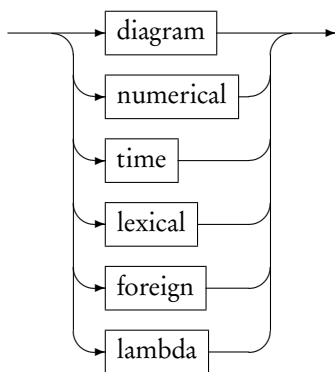

### 3.4.1 Diagram Expressions

Diagram expressions are assembled from primitive ones using either binary composition operations or high level iterative constructions.

*diagramexp*

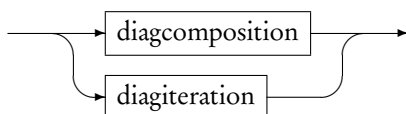

### Diagram composition operations

Five binary *composition operations* are available to combine block-diagrams : *recursion*, *parallel*, *sequential*, *split* and *merge* composition. One can think of each of these composition operations as a particular way to connect two block diagrams.

*diagcomposition*

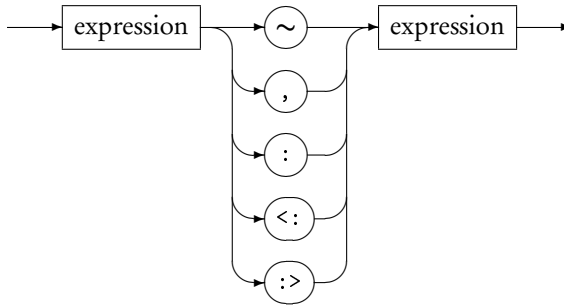

To describe precisely how these connections are done, we have to introduce some notation. The number of inputs and outputs of a bloc-diagram  $A$  are notated  $\text{inputs}(A)$  and  $\text{outputs}(A)$ . The inputs and outputs themselves are respectively notated :  $[0]A$ ,  $[1]A$ ,  $[2]A$ , ... and  $A[0]$ ,  $A[1]$ ,  $A[2]$ , etc..

For each composition operation between two block-diagrams  $A$  and  $B$  we will describe the connections  $A[i] \rightarrow [j]B$  that are created and the constraints on their relative numbers of inputs and outputs.

The priority and associativity of this five operations are given table 3.1.

Syntax	Pri.	Assoc.	Description
$\text{expression} \sim \text{expression}$	4	left	recursive composition
$\text{expression} , \text{expression}$	3	right	parallel composition
$\text{expression} : \text{expression}$	2	right	sequential composition
$\text{expression} <: \text{expression}$	1	right	split composition
$\text{expression} :> \text{expression}$	1	right	merge composition

Table 3.1: Block-Diagram composition operation priorities

**Parallel Composition** The *parallel composition*  $(A, B)$  (figure 3.2) is probably the simplest one. It places the two block-diagrams one on top of the other, without connections. The inputs of the resulting block-diagram are the inputs of  $A$  and  $B$ . The outputs of the resulting block-diagram are the outputs of  $A$  and  $B$ .

*Parallel composition* is an associative operation :  $(A, (B, C))$  and  $((A, B), C)$  are equivalents. When no parenthesis are used :  $A, B, C, D$ , FAUST uses right associativity and therefore build internally the expression  $(A, (B, (C, D)))$ . This organization is important to know when using pattern matching techniques on parallel compositions.

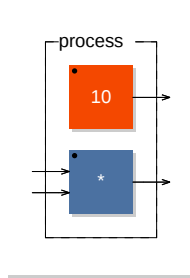

Figure 3.2: Example of parallel composition  $(10, *)$

**Sequential Composition** The *sequential composition*  $A : B$  (figure 3.3) expects:

$$\text{outputs}(A) = \text{inputs}(B) \tag{3.1}$$

It connects each output of  $A$  to the corresponding input of  $B$ :

$$A[i] \rightarrow [i]B \tag{3.2}$$

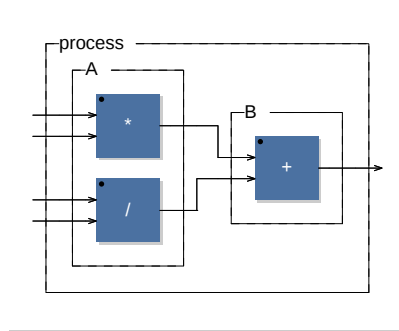

Figure 3.3: Example of sequential composition  $((*, /) : +)$

*Sequential composition* is an associative operation :  $(A : (B : C))$  and  $((A : B) : C)$  are equivalent. When no parenthesis are used, like in  $A : B : C : D$ , FAUST uses right associativity and therefore build internally the expression  $(A : (B : (C : D)))$ .

**Split Composition** The *split composition*  $A < : B$  (figure 3.4) operator is used to distribute the outputs of  $A$  to the inputs of  $B$ .

For the operation to be valid the number of inputs of  $B$  must be a multiple of the number of outputs of  $A$  :

$$\text{outputs}(A) \cdot k = \text{inputs}(B) \tag{3.3}$$

Each input  $i$  of  $B$  is connected to the output  $i \bmod k$  of  $A$  :

$$A[i \bmod k] \rightarrow [i]B \tag{3.4}$$

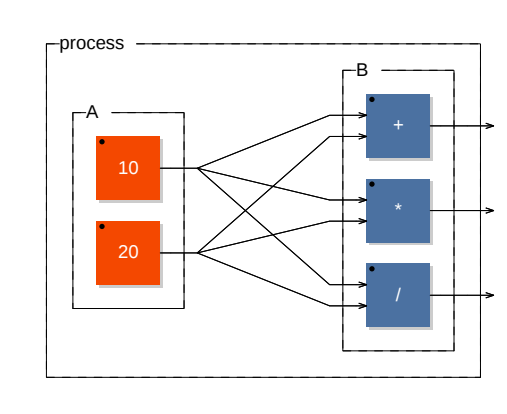

Figure 3.4: example of split composition  $((10, 20) <: (+, *, /))$

**Merge Composition** The *merge composition*  $A :> B$  (figure 3.5) is the dual of the *split composition*. The number of outputs of  $A$  must be a multiple of the number of inputs of  $B$  :

$$\text{outputs}(A) = k \cdot \text{inputs}(B) \quad (3.5)$$

Each output  $i$  of  $A$  is connected to the input  $i \bmod k$  of  $B$  :

$$A[i] \rightarrow [i \bmod k]B \quad (3.6)$$

The  $k$  incoming signals of an input of  $B$  are summed together.

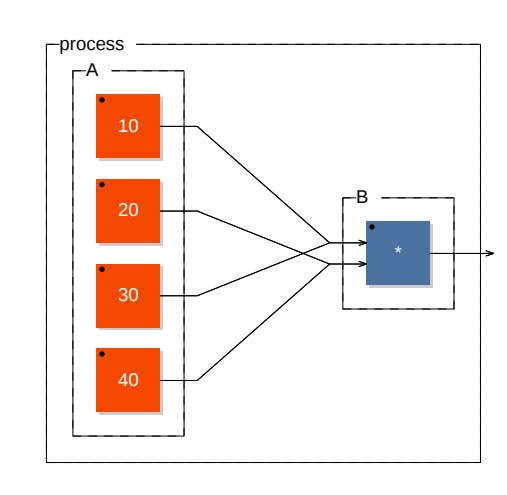

Figure 3.5: example of merge composition  $((10, 20, 30, 40) :> *)$

**Recursive Composition** The *recursive composition*  $A \sim B$  (figure 3.6) is used to create cycles in the block-diagram in order to express recursive computations. It is the most complex operation in terms of connections.

To be applicable it requires that :

$$\text{outputs}(A) \geq \text{inputs}(B) \text{ and } \text{inputs}(A) \geq \text{outputs}(B) \quad (3.7)$$

Each input of  $B$  is connected to the corresponding output of  $A$  via an implicit 1-sample delay :

$$A[i] \xrightarrow{Z^{-1}} [i]B \quad (3.8)$$

and each output of  $B$  is connected to the corresponding input of  $A$ :

$$B[i] \rightarrow [i]A \quad (3.9)$$

The inputs of the resulting block diagram are the remaining unconnected inputs of  $A$ . The outputs are all the outputs of  $A$ .

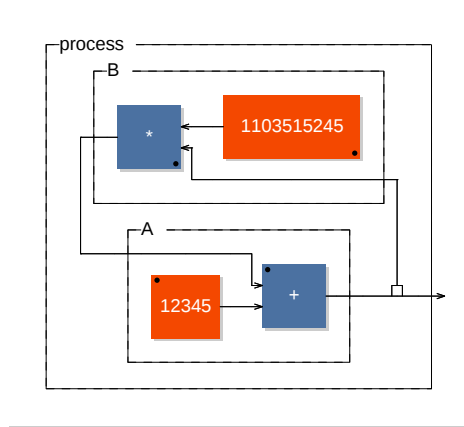
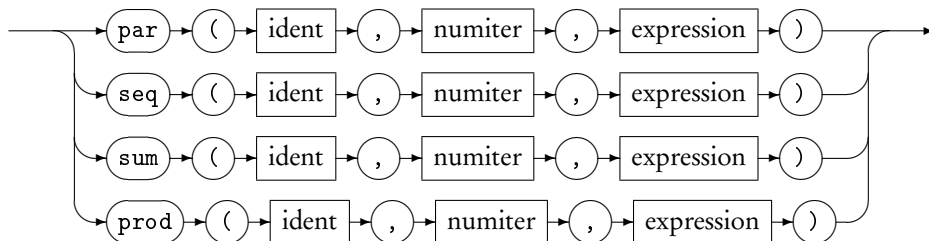

Figure 3.6: example of recursive composition  $+(12345) \sim *(1103515245)$

### Iterations

Iterations are analogous to `for(...)` loops and provide a convenient way to automate some complex block-diagram constructions.

#### diagiteration



The following example shows the usage of `seq` to create a 10-bands filter:

```

process = seq(i, 10,
              vgroup("band %i",
                    bandfilter( 1000*(1+i) )
              )
);

```

*numiter*

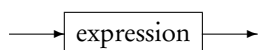

The number of iterations must be a constant expression.

### 3.4.2 Numerical Expressions

Numerical expressions are essentially syntactic sugar allowing to use a familiar infix notation to express mathematical expressions, bitwise operations and to compare signals. Please note that in this section only built-in primitives with an infix syntax are presented. A complete description of all the build-ins is available in the primitive section (see 3.5).

*numerical*

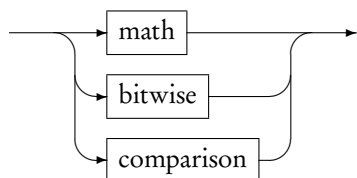

#### Mathematical expressions

are the familiar 4 operations as well as the modulo and power operations

*math*

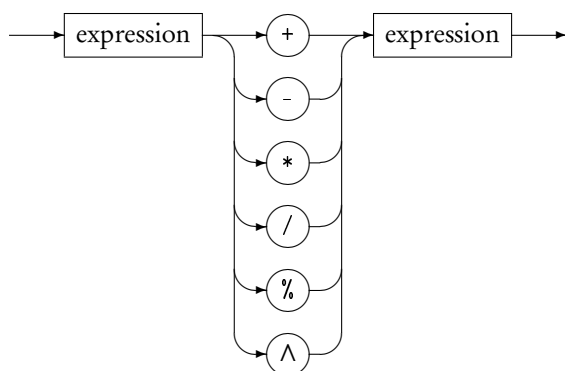

**Bitwise expressions**

are the boolean operations and the left and right arithmetic shifts.

*bitwise*

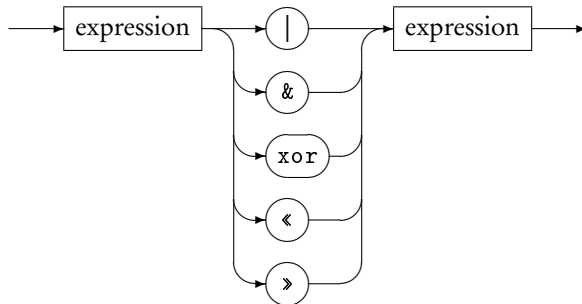
**Comparison**

operations allow to compare signals and result in a boolean signal that is 1 when the condition is true and 0 when the condition is false.

*comparison*

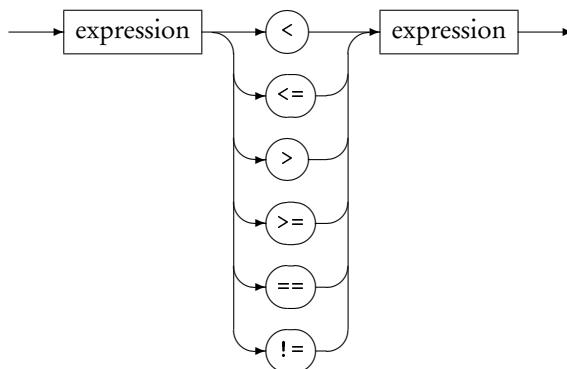
**3.4.3 Time expressions**

Time expressions are used to express delays. The notation  $X@10$  represent the signal  $X$  delayed by 10 samples. The notation  $X'$  represent the signal  $X$  delayed by one sample and is therefore equivalent to  $X@1$ .

*time*

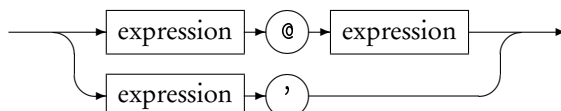

The delay don't have to be fixed, but it must be positive and bounded. The values of a slider are perfectly acceptable as in the following example:

```
process = _ @ hslider("delay",0, 0, 100, 1);
```

### 3.4.4 Environment expressions

FAUST is a lexically scoped language. The meaning of a FAUST expression is determined by its context of definition (its lexical environment) and not by its context of use.

To keep their original meaning, FAUST expressions are bounded to their lexical environment in structures called *closures*. The following constructions allow to explicitly create and access such environments. Moreover they provide powerful means to reuse existing code and promote modular design.

*envexp*

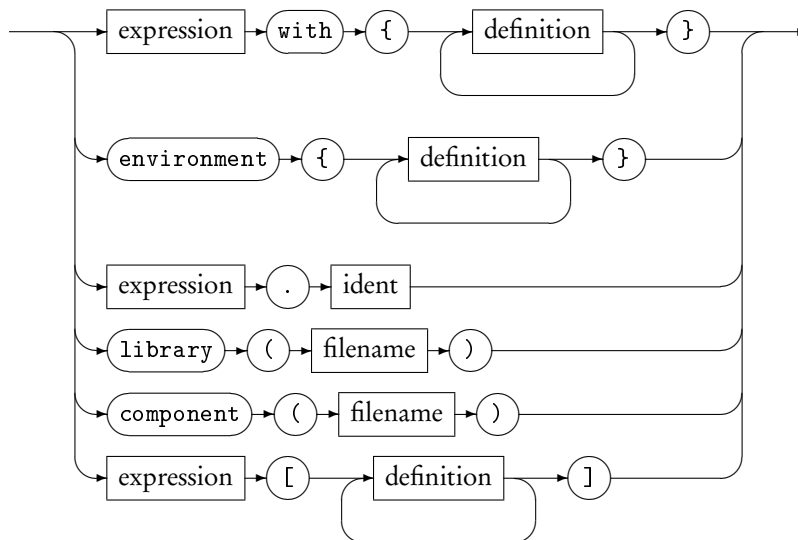

#### With

The `with` construction allows to specify a *local environment*, a private list of definition that will be used to evaluate the left hand expression

*withexpression*

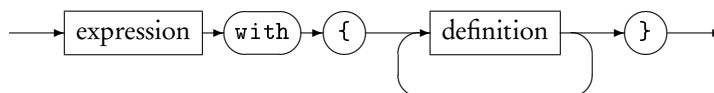

In the following example :

```
pink = f : + ~ g with {
    f(x) = 0.04957526213389*x
```



```

- 0.06305581334498*x'
+ 0.01483220320740*x'';
g(x) = 1.80116083982126*x
- 0.80257737639225*x';
};

```

the definitions of  $f(x)$  and  $g(x)$  are local to  $f : + \sim g$ .

Please note that `with` is left associative and has the lowest priority:

- $f : + \sim g$  with  $\{...\}$  is equivalent to  $(f : + \sim g)$  with  $\{...\}$ .
- $f : + \sim g$  with  $\{...\}$  with  $\{...\}$  is equivalent to  $((f : + \sim g)$  with  $\{...\})$  with  $\{...\}$ .

### Environment

The `environment` construction allows to create an explicit environment. It is like a `with`, but without the left hand expression. It is a convenient way to group together related definitions, to isolate groups of definitions and to create a name space hierarchy.

*environment*

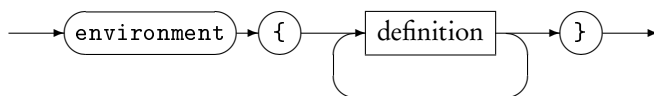

In the following example an `environment` construction is used to group together some constant definitions :

```

constant = environment {
  pi = 3.14159;
  e = 2,718 ;
  ...
};

```

The `.` construction allows to access the definitions of an environment (see next paragraph).

### Access

Definitions inside an environment can be accessed using the `'.'` construction.

*access*

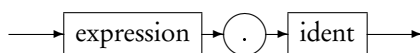

For example `constant.pi` refers to the definition of `pi` in the above `constant` environment.

Please note that environment don't have to be named. We could have written directly `environment{pi = 3.14159; e = 2,718; ...}.pi`

## Library

The `library` construct allows to create an environment by reading the definitions from a file.

*library*

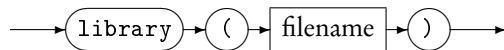

For example `library("filter.lib")` represents the environment obtained by reading the file "filter.lib". It works like `import("filter.lib")` but all the read definitions are stored in a new separate lexical environment. Individual definitions can be accessed as described in the previous paragraph. For example `library("filter.lib").lowpass` denotes the function `lowpass` as defined in the file "filter.lib".

To avoid name conflicts when importing libraries it is recommended to prefer `library` to `import`. So instead of :

```
import("filter.lib");
...
...lowpass...
...
};
```

the following will ensure an absence of conflicts :

```
f1 = library("filter.lib");
...
...f1.lowpass...
...
};
```

## Component

The `component(...)` construction allows to reuse a full FAUST program as a simple expression.

*component*

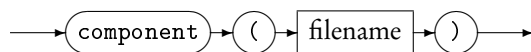

For example `component("freeverb.dsp")` denotes the signal processor defined in file "freeverb.dsp".

Components can be used within expressions like in:

```
... component("karplus32.dsp") : component("freeverb.dsp")
...
```

Please note that `component("freeverb.dsp")` is equivalent to `library("freeverb.dsp").process`.

### Explicit substitution

Explicit substitution can be used to customize a component or any expression with a lexical environment by replacing some of its internal definitions, without having to modify it.

*explicitsubst*

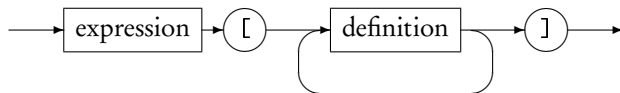

For example we can create a customized version of `component("freeverb.dsp")`, with a different definition of `foo(x)`, by writing :

```
... component("freeverb.dsp") [foo(x) = ...;] ...
};
```

### 3.4.5 Foreign expressions

Reference to external C *functions*, *variables* and *constants* can be introduced using the *foreign function* mechanism.

*foreignexp*

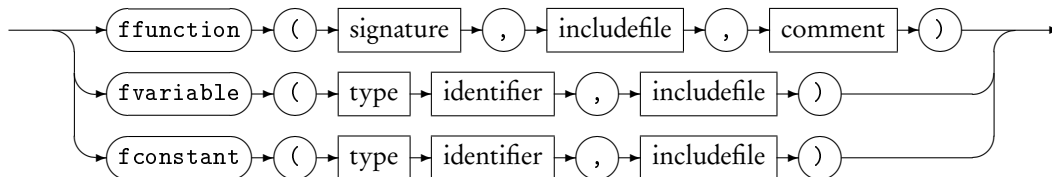

### ffunction

An external C function is declared by indicating its name and signature as well as the required include file. The file `"math.lib"` of the FAUST distribution contains several foreign function definitions, for example the inverse hyperbolic sine function `asinh`:

```
asinh = ffunction(float asinhf (float), <math.h>, "");
```

Foreign functions with input parameters are considered pure math functions. They are therefore considered free of side effects and called only when their parameters change (that is at the rate of the fastest parameter).

Exceptions are functions with no input parameters. A typical example is the C `rand()` function. In this case the compiler generate code to call the function at sample rate.

**signature**

The signature part (`float asinhf (float)` in our previous example) describes the prototype of the C function : return type, function name and list of parameter types.

*signature*

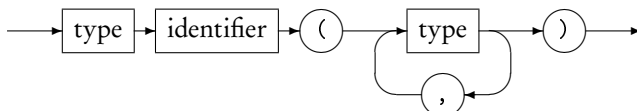
**types**

Note that currently only numerical functions involving simple int and float parameters are allowed. No vectors, tables or data structures can be passed as parameters or returned.

*type*

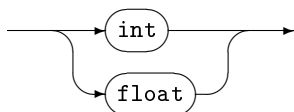
**variables and constants**

External variables and constants can also be declared with a similar syntax. In the same "`math.lib`" file we can find the definition of the sampling rate constant `SR` and the definition of the block-size variable `BS` :

```
SR      = fconstant(int fSamplingFreq, <math.h>);
BS      = fvariable(int count, <math.h>);
```

Foreign constants are not supposed to vary. Therefore expressions involving only foreign constants are only computed once, during the initialization period.

Variables are considered to vary at block speed. This means that expressions depending on external variables are computed every block.

**include file**

In declaring foreign functions one also has to specify the include file. It allows the FAUST compiler to add the corresponding `#include...` in the generated code.

*includefile*

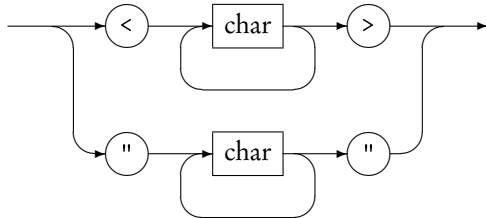

### 3.4.6 Applications and Abstractions

*Abstractions* and *applications* are fundamental programming constructions directly inspired by the Lambda-Calculus. These constructions provide powerful ways to describe and transform block-diagrams algorithmically.

*progexp*

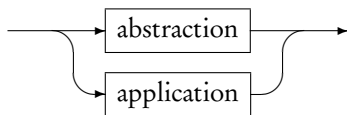

#### Abstractions

Abstractions correspond to functions definitions and allow to generalize a block-diagram by *making variable* some of its parts.

*abstraction*

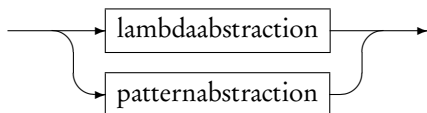

*lambdaabstraction*

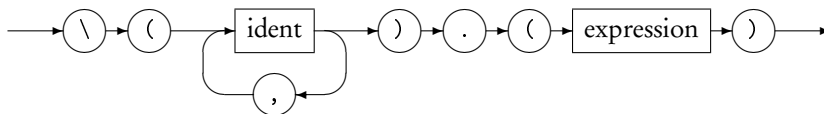

Let's say you want to transform a stereo reverb, `freeverb` for instance, into a mono effect. You can write the following expression:

```
_ <: freeverb :> _
```

The incoming mono signal is splitted to feed the two input channels of the reverb, while the two output channels of the reverb are mixed together to produce the resulting mono output.

Imagine now that you are interested in transforming other stereo effects. It can be interesting to generalize this principle by making `freeverb` a variable:

```
\(freeverb).( _ <: freeverb :> _ )
```

The resulting abstraction can then be applied to transform other effects. Note that if `freeverb` is a perfectly valid variable name, a more neutral name would probably be easier to read like:

```
\(fx).( _ <: fx :> _ )
```

Moreover it could be convenient to give a name to this abstraction:

```
mono = \(fx).( _ <: fx :> _ );
```

Or even use a more traditional, but equivalent, notation:

```
mono(fx) = _ <: fx :> _;
```

### Applications

Applications correspond to function calls and allow to replace the variable parts of an abstraction with the specified arguments.

*application*

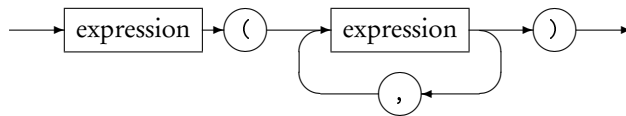

For example you can apply the previous abstraction to transform your stereo harmonizer:

```
mono(harmonizer)
```

The compiler will start by replacing `mono` by its definition:

```
\(fx).( _ <: fx :> _ )(harmonizer)
```

Whenever the FAUST compiler find an application of an abstraction it replaces the *variable part* with the argument. The resulting expression is as expected:

```
( _ <: harmonizer :> _ )
```

Replacing the *variable part* with the argument is called  $\beta$ -reduction in Lambda-Calculus

### Pattern Matching

Pattern matching rules provide an effective way to analyze and transform block-diagrams algorithmically.

*patternabstraction*

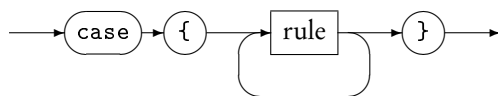

*Rule*

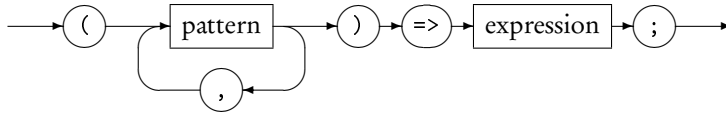

*Pattern*

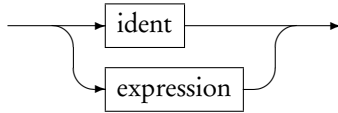

For example `case{ (x:y)=> y:x; (x)=> x; }` contains two rules. The first one will match a sequential expression and invert the two part. The second one will match all remaining expressions and leave it untouched. Therefore the application:

```
case{(x:y) => y:x; (x) => x;}(freeverb:harmonizer)
```

will produce:

```
(harmonizer:freeverb)
```

Please note that patterns are evaluated before the pattern matching operation. Therefore only variables that appear free in the pattern are binding variables during pattern matching.

## 3.5 Primitives

The primitive signal processing operations represent the built-in functionalities of FAUST, that is the atomic operations on signals provided by the language. All these primitives denote *signal processors*, functions transforming *input signals* into *output signals*.

### 3.5.1 Numbers

FAUST considers two types of numbers: *integers* and *floats*. Integers are implemented as 32-bits integers, and floats are implemented either with a simple, double or extended precision depending of the compiler options. Floats are available in decimal or scientific notation.

*int*

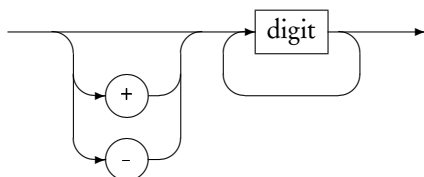

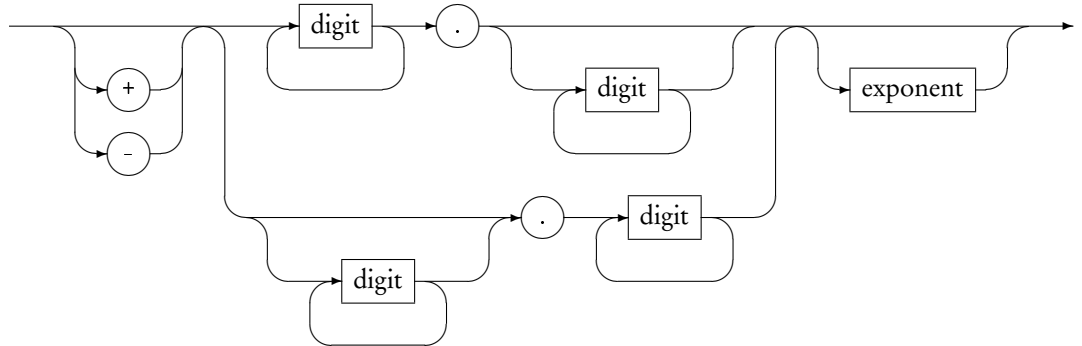
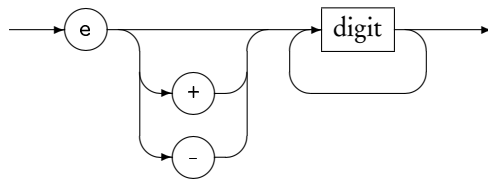
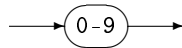
*float**exponent**digit*

Like any other FAUST expression, numbers are signal processors. For example the number 0.95 is a signal processor of type  $\mathbb{S}^0 \rightarrow \mathbb{S}^1$  that transforms an empty tuple of signals  $()$  into a 1-tuple of signals  $(y)$  such that  $\forall t \in \mathbb{N}, y(t) = 0.95$ .

### 3.5.2 C-equivalent primitives

Most FAUST primitives are analogue to their C counterpart but lifted to signal processing. For example  $+$  is a function of type  $\mathbb{S}^2 \rightarrow \mathbb{S}^1$  that transforms a pair of signals  $(x_1, x_2)$  into a 1-tuple of signals  $(y)$  such that  $\forall t \in \mathbb{N}, y(t) = x_1(t) + x_2(t)$ .



Syntax	Type	Description
$n$	$\mathbb{S}^0 \rightarrow \mathbb{S}^1$	integer number: $y(t) = n$
$n.m$	$\mathbb{S}^0 \rightarrow \mathbb{S}^1$	floating point number: $y(t) = n.m$
$_$	$\mathbb{S}^1 \rightarrow \mathbb{S}^1$	identity function: $y(t) = x(t)$
$!$	$\mathbb{S}^1 \rightarrow \mathbb{S}^0$	cut function: $\forall x \in \mathbb{S}, (x) \rightarrow ()$
<code>int</code>	$\mathbb{S}^1 \rightarrow \mathbb{S}^1$	cast into an int signal: $y(t) = (\text{int})x(t)$
<code>float</code>	$\mathbb{S}^1 \rightarrow \mathbb{S}^1$	cast into an float signal: $y(t) = (\text{float})x(t)$
$+$	$\mathbb{S}^2 \rightarrow \mathbb{S}^1$	addition: $y(t) = x_1(t) + x_2(t)$
$-$	$\mathbb{S}^2 \rightarrow \mathbb{S}^1$	subtraction: $y(t) = x_1(t) - x_2(t)$
$*$	$\mathbb{S}^2 \rightarrow \mathbb{S}^1$	multiplication: $y(t) = x_1(t) * x_2(t)$
$\wedge$	$\mathbb{S}^2 \rightarrow \mathbb{S}^1$	power: $y(t) = x_1(t)^{x_2(t)}$
$/$	$\mathbb{S}^2 \rightarrow \mathbb{S}^1$	division: $y(t) = x_1(t) / x_2(t)$
$\%$	$\mathbb{S}^2 \rightarrow \mathbb{S}^1$	modulo: $y(t) = x_1(t) \% x_2(t)$
$\&$	$\mathbb{S}^2 \rightarrow \mathbb{S}^1$	logical AND: $y(t) = x_1(t) \& x_2(t)$
$ $	$\mathbb{S}^2 \rightarrow \mathbb{S}^1$	logical OR: $y(t) = x_1(t)   x_2(t)$
<code>xor</code>	$\mathbb{S}^2 \rightarrow \mathbb{S}^1$	logical XOR: $y(t) = x_1(t) \wedge x_2(t)$
$\ll$	$\mathbb{S}^2 \rightarrow \mathbb{S}^1$	arith. shift left: $y(t) = x_1(t) \ll x_2(t)$
$\gg$	$\mathbb{S}^2 \rightarrow \mathbb{S}^1$	arith. shift right: $y(t) = x_1(t) \gg x_2(t)$
$<$	$\mathbb{S}^2 \rightarrow \mathbb{S}^1$	less than: $y(t) = x_1(t) < x_2(t)$
$\leq$	$\mathbb{S}^2 \rightarrow \mathbb{S}^1$	less or equal: $y(t) = x_1(t) \leq x_2(t)$
$>$	$\mathbb{S}^2 \rightarrow \mathbb{S}^1$	greater than: $y(t) = x_1(t) > x_2(t)$
$\geq$	$\mathbb{S}^2 \rightarrow \mathbb{S}^1$	greater or equal: $y(t) = x_1(t) \geq x_2(t)$
$==$	$\mathbb{S}^2 \rightarrow \mathbb{S}^1$	equal: $y(t) = x_1(t) == x_2(t)$
$!=$	$\mathbb{S}^2 \rightarrow \mathbb{S}^1$	different: $y(t) = x_1(t) != x_2(t)$

### 3.5.3 math.h-equivalent primitives

Most of the C `math.h` functions are also built-in as primitives (the others are defined as external functions in file `math.lib`).

Syntax	Type	Description
acos	$\mathbb{S}^1 \rightarrow \mathbb{S}^1$	arc cosine: $y(t) = \text{acosf}(x(t))$
asin	$\mathbb{S}^1 \rightarrow \mathbb{S}^1$	arc sine: $y(t) = \text{asinf}(x(t))$
atan	$\mathbb{S}^1 \rightarrow \mathbb{S}^1$	arc tangent: $y(t) = \text{atanf}(x(t))$
atan2	$\mathbb{S}^2 \rightarrow \mathbb{S}^1$	arc tangent of 2 signals: $y(t) = \text{atan2f}(x_1(t), x_2(t))$
cos	$\mathbb{S}^1 \rightarrow \mathbb{S}^1$	cosine: $y(t) = \text{cosf}(x(t))$
sin	$\mathbb{S}^1 \rightarrow \mathbb{S}^1$	sine: $y(t) = \text{sinf}(x(t))$
tan	$\mathbb{S}^1 \rightarrow \mathbb{S}^1$	tangent: $y(t) = \text{tanf}(x(t))$
exp	$\mathbb{S}^1 \rightarrow \mathbb{S}^1$	base-e exponential: $y(t) = \text{expf}(x(t))$
log	$\mathbb{S}^1 \rightarrow \mathbb{S}^1$	base-e logarithm: $y(t) = \text{logf}(x(t))$
log10	$\mathbb{S}^1 \rightarrow \mathbb{S}^1$	base-10 logarithm: $y(t) = \text{log10f}(x(t))$
pow	$\mathbb{S}^2 \rightarrow \mathbb{S}^1$	power: $y(t) = \text{powf}(x_1(t), x_2(t))$
sqrt	$\mathbb{S}^1 \rightarrow \mathbb{S}^1$	square root: $y(t) = \text{sqrtf}(x(t))$
abs	$\mathbb{S}^1 \rightarrow \mathbb{S}^1$	absolute value (int): $y(t) = \text{abs}(x(t))$ absolute value (float): $y(t) = \text{fabsf}(x(t))$
min	$\mathbb{S}^2 \rightarrow \mathbb{S}^1$	minimum: $y(t) = \text{min}(x_1(t), x_2(t))$
max	$\mathbb{S}^2 \rightarrow \mathbb{S}^1$	maximum: $y(t) = \text{max}(x_1(t), x_2(t))$
fmod	$\mathbb{S}^2 \rightarrow \mathbb{S}^1$	float modulo: $y(t) = \text{fmodf}(x_1(t), x_2(t))$
remainder	$\mathbb{S}^2 \rightarrow \mathbb{S}^1$	float remainder: $y(t) = \text{remainderf}(x_1(t), x_2(t))$
floor	$\mathbb{S}^1 \rightarrow \mathbb{S}^1$	largest int $\leq$ : $y(t) = \text{floorf}(x(t))$
ceil	$\mathbb{S}^1 \rightarrow \mathbb{S}^1$	smallest int $\geq$ : $y(t) = \text{ceilf}(x(t))$
rint	$\mathbb{S}^1 \rightarrow \mathbb{S}^1$	closest int: $y(t) = \text{rintf}(x(t))$

### 3.5.4 Delay, Table, Selector primitives

The following primitives allow to define fixed delays, read-only and read-write tables and 2 or 3-ways selectors (see figure 3.7).

Syntax	Type	Description
mem	$\mathbb{S}^1 \rightarrow \mathbb{S}^1$	1-sample delay: $y(t+1) = x(t), y(0) = 0$
prefix	$\mathbb{S}^2 \rightarrow \mathbb{S}^1$	1-sample delay: $y(t+1) = x_2(t), y(0) = x_1(0)$
@	$\mathbb{S}^2 \rightarrow \mathbb{S}^1$	fixed delay: $y(t+x_2(t)) = x_1(t), y(t < x_2(t)) = 0$
rdtable	$\mathbb{S}^3 \rightarrow \mathbb{S}^1$	read-only table: $y(t) = T[r(t)]$
rwttable	$\mathbb{S}^5 \rightarrow \mathbb{S}^1$	read-write table: $T[w(t)] = c(t); y(t) = T[r(t)]$
select2	$\mathbb{S}^3 \rightarrow \mathbb{S}^1$	select between 2 signals: $T[] = \{x_0(t), x_1(t)\}; y(t) = T[s(t)]$
select3	$\mathbb{S}^4 \rightarrow \mathbb{S}^1$	select between 3 signals: $T[] = \{x_0(t), x_1(t), x_2(t)\}; y(t) = T[s(t)]$

### 3.5.5 User Interface Elements

FAUST user interface widgets allow an abstract description of the user interface from within the FAUST code. This description is independent of any GUI toolkits. It is based on *buttons*, *checkboxes*, *sliders*, etc. that are grouped together vertically and horizontally using appropriate grouping schemes.

All these GUI elements produce signals. A button for example (see figure 3.8) produces a signal which is 1 when the button is pressed and 0 otherwise. These signals can be freely combined with other audio signals.

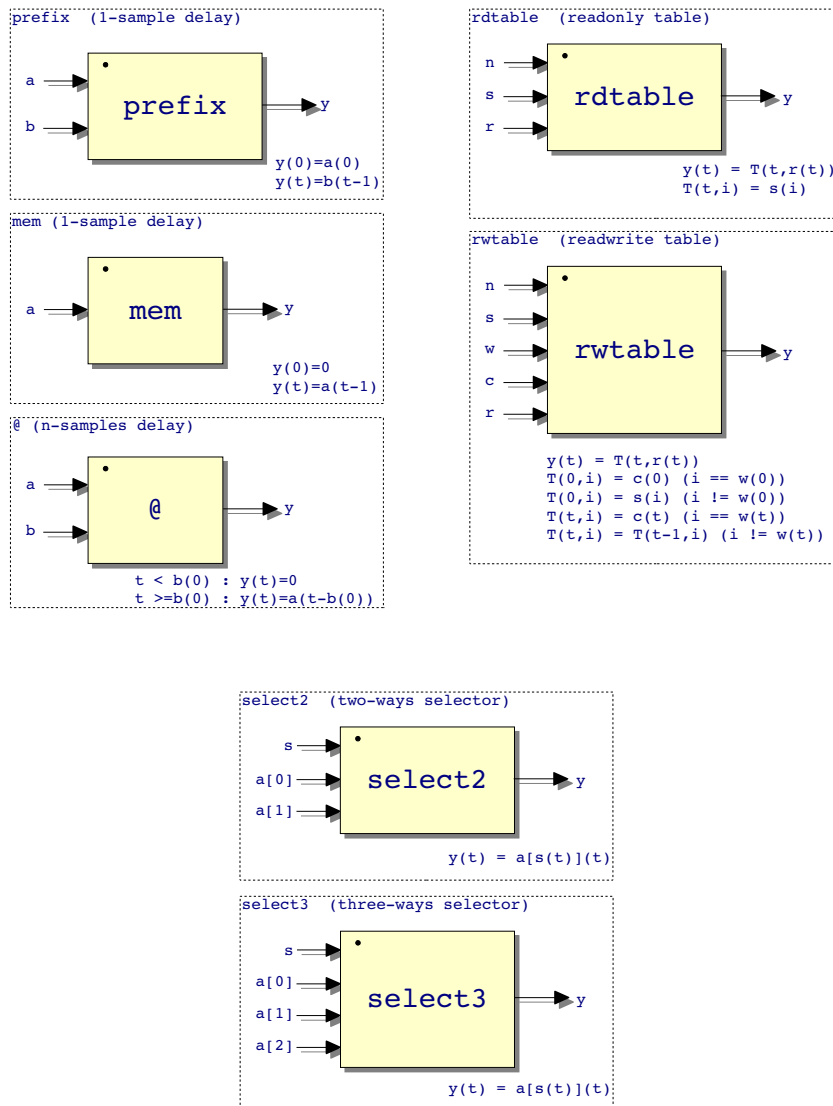

Figure 3.7: Delays, tables and selectors primitives

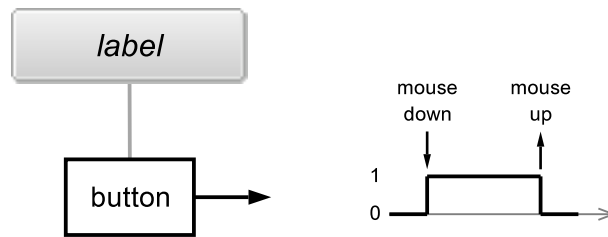

Figure 3.8: User Interface Button

Syntax	Example
<code>button(str)</code>	<code>button("play")</code>
<code>checkbox(str)</code>	<code>checkbox("mute")</code>
<code>vslider(str, cur, min, max, step)</code>	<code>vslider("vol", 50, 0, 100, 1)</code>
<code>hslider(str, cur, min, max, step)</code>	<code>hslider("vol", 0.5, 0, 1, 0.01)</code>
<code>nentry(str, cur, min, max, step)</code>	<code>nentry("freq", 440, 0, 8000, 1)</code>
<code>vgroup(str, block-diagram)</code>	<code>vgroup("reverb", ...)</code>
<code>hgroup(str, block-diagram)</code>	<code>hgroup("mixer", ...)</code>
<code>tgroup(str, block-diagram)</code>	<code>tgroup("parametric", ...)</code>
<code>vbargraph(str, min, max)</code>	<code>vbargraph("input", 0, 100)</code>
<code>hbargraph(str, min, max)</code>	<code>hbargraph("signal", 0, 1.0)</code>
<code>attach</code>	<code>attach(x, vumeter(x))</code>

## Labels

Every user interface widget has a label (a string) that identifies it and informs the user of its purpose. There are three important mechanisms associated with labels (and coded inside the string): *variable parts*, *pathnames* and *metadata*.

**Variable parts.** Labels can contain variable parts. These variable parts are indicated by the sign `%` followed by the name of a variable. During compilation each label is processed in order to replace the variable parts by the value of the variable. For example `par(i,8,hslider("Voice %i", 0.9, 0, 1, 0.01))` creates 8 different sliders in parallel :

```
hslider("Voice 0", 0.9, 0, 1, 0.01),
hslider("Voice 1", 0.9, 0, 1, 0.01),
...
hslider("Voice 7", 0.9, 0, 1, 0.01).
```

while `par(i,8,hslider("Voice", 0.9, 0, 1, 0.01))` would have created only one slider and duplicated its output 8 times.

The variable part can have an optional format digit. For example `"Voice %2i"` would indicate to use two digit when inserting the value of `i` in the string.

An escape mechanism is provided. If the sign `%` is followed by itself, it will be included in the resulting string. For example `feedback (%)` will result in `feedback (%)`.

**Pathnames.** Thanks to horizontal, vertical and tabs groups, user interfaces have a hierarchical structure analog to a hierarchical file system. Each widget has an associated *pathname* obtained by concatenating the labels of all its surrounding groups with its own label.

In the following example :

```
hgroup("Foo",
  ...
  vgroup("Faa",
    ...
    hslider("volume", ...)
    ...
  )
  ...
)
```

the volume slider has pathname `/h:Foo/v:Faa/volume`.

In order to give more flexibility to the design of user interfaces, it is possible to explicitly specify the absolute or relative pathname of a widget directly in its label.

In our previous example the pathname of :

```
hslider("../volume", ...)
```

would have been `/h:Foo/volume`, while the pathname of :

```
hslider("t:Fii/volume", ...)
```

would have been `/h:Foo/v:Faa/t:Fii/volume`.

The grammar for labels with pathnames is the following:

*label*

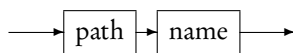

*path*

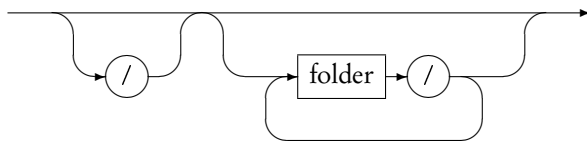

*folder*

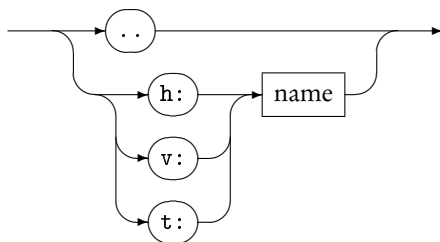

**Metadata** Widget labels can contain metadata enclosed in square brackets. These metadata associate a key with a value and are used to provide additional information to the architecture file. They are typically used to improve the look and feel of the user interface. The FAUST code :

```
process = *(hslider("foo [key1: val 1][key2: val 2]",
                   0, 0, 1, 0.1));
```

will produce and the corresponding C++ code :

```
class mydsp : public dsp {
    ...
    virtual void buildUserInterface(UI* interface) {
        interface->openVerticalBox("m");
        interface->declare(&fslider0, "key1", "val 1");
        interface->declare(&fslider0, "key2", "val 2");
        interface->addHorizontalSlider("foo", &fslider0,
                                     0.0f, 0.0f, 1.0f, 0.1f);
        interface->closeBox();
    }
    ...
};
```

All the metadata are removed from the label by the compiler and transformed in calls to the `UI::declare()` method. All these `UI::declare()` calls will always take place before the `UI::AddSomething()` call that creates the User Interface element. This allows the `UI::AddSomething()` method to make full use of the available metadata.

It is the role of the architecture file to decide what to do with these metadata. The `jack-qt.cpp` architecture file for example implements the following :

1. "...[style:knob]..." creates a rotating knob instead of a regular slider or nentry.
2. "...[style:led]..." in a bargraph's label creates a small LED instead of a full bargraph
3. "...[unit:dB]..." in a bargraph's label creates a more realistic bargraph with colors ranging from green to red depending of the level of the value
4. "...[unit:xx]..." in a widget postfixes the value displayed with xx
5. "...[tooltip:bla bla]..." add a tooltip to the widget
6. "...[osc:/address min max]..." Open Sound Control message alias

Moreover starting a label with a number option like in "[1]..." provides a convenient means to control the alphabetical order of the widgets.

### Attach

The `attach` primitive takes two input signals and produce one output signal which is a copy of the first input. The role of `attach` is to force its second input signal to

be compiled with the first one. From a mathematical point of view `attach(x,y)` is equivalent to `1*x+0*y`, which is in turn equivalent to `x`, but it tells the compiler not to optimize-out `y`.

To illustrate this role let say that we want to develop a mixer application with a vumeter for each input signals. Such vumeters can be easily coded in FAUST using an envelop detector connected to a bargraph. The problem is that these envelop signals have no role in the output signals. Using `attach(x,vumeter(x))` one can tel the compiler that when `x` is compiled `vumeter(x)` should also be compiled.





## Chapter 4

# Invoking the FAUST compiler

The FAUST compiler is invoked using the `faust` command. It translates FAUST programs into C++ code. The generated code can be wrapped into an optional *architecture file* allowing to directly produce a fully operational program.

*compiler*

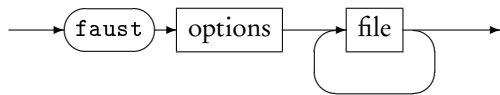

For example `faust noise.dsp` will compile `noise.dsp` and output the corresponding C++ code on the standard output. The option `-o` allows to choose the output file: `faust noise.dsp -o noise.cpp`. The option `-a` allows to choose the architecture file: `faust -a alsa-gtk.cpp noise.dsp`.

To compile a FAUST program into an ALSA application on Linux you can use the following commands:

```
faust -a alsa-gtk.cpp noise.dsp -o noise.cpp
g++ -lpthread -lasound
    'pkg-config --cflags --libs gtk+-2.0'
    noise.cpp -o noise
```

### 4.1 Compilation options

Compilation options are listed in the following table :

Short	Long	Description
-h	-help	print the help message
-v	-version	print version information
-d	-details	print compilation details
-tg	-task-graph	draw a graph of all internal computation loops as a .dot (graphviz) file.
-sg	-signal-graph	draw a graph of all internal signal expressions as a .dot (graphviz) file.
-ps	-postscript	generate block-diagram postscript files
-svg	-svg	generate block-diagram svg files
-blur	-shadow-blur	add a blur to boxes shadows
-sd	-simplify-diagrams	simplify block-diagram before drawing them
-f <i>n</i>	-fold <i>n</i>	max complexity of svg diagrams before splitting into several files (default 25 boxes)
-mns <i>n</i>	-max-name-size <i>n</i>	max character size used in svg diagram labels
-sn	-simple-names	use simple names (without arguments) for block-diagram (default max size : 40 chars)
-xml	-xml	generate an additional description file in xml format
-uim	-user-interface-macros	add user interface macro definitions to the C++ code
-flist	-file-list	list all the source files and libraries implied in a compilation
-norm	-normalized-form	prints the internal signals in normalized form and exits
-lb	-left-balanced	generate left-balanced expressions
-mb	-mid-balanced	generate mid-balanced expressions (default)
-rb	-right-balanced	generate right-balanced expressions
-lt	-less-temporaries	generate less temporaries in compiling delays
-mcd <i>n</i>	-max-copy-delay <i>n</i>	threshold between copy and ring buffer delays (default 16 samples)
-vec	-vectorize	generate easier to vectorize code
-vs <i>n</i>	-vec-size <i>n</i>	size of the vector (default 32 samples) when -vec
-lv <i>n</i>	-loop-variant <i>n</i>	loop variant [0:fastest (default), 1:simple] when -vec
-dfs	-deepFirstScheduling	schedule vector loops in deep first order when -vec
-omp	-openMP	generate parallel code using OpenMP (implies -vec)

*continued on next page*

Short	Long	Description
-sch	-scheduler	generate parallel code using threads directly (implies -vec)
-g	-groupTasks	group sequential tasks together when -omp or -sch is used
-single	-single-precision-floats	use floats for internal computations (default)
-double	-double-precision-floats	use doubles for internal computations
-quad	-quad-precision-floats	use extended for internal computations
-mdoc	-mathdoc	generates the full mathematical description of a FAUST program
-mdlang <i>l</i>	-mathdoc-lang <i>l</i>	choose the language of the mathematical description ( <i>l</i> = en, fr, ...)
-stripmdoc	-strip-mdoc-tags	remove documentation tags when printing FAUST listings
-cn <i>name</i>	-class-name <i>name</i>	name of the dsp class to be used instead of 'mydsp'
-t <i>time</i>	-timeout <i>time</i>	time out of time seconds (default 600) for the compiler to abort
-a <i>file</i>		architecture file to use
-o <i>file</i>		C++ output file



## Chapter 5

# Architecture files

A FAUST program describes a *signal processor*, a pure computation that maps *input signals* to *output signals*. It says nothing about audio drivers or GUI toolkits. This missing information is provided by *architecture files*.

An *architecture file* describes how to relate a FAUST program to the external world, in particular the audio drivers and the user interface to be used. This approach allows a single FAUST program to be easily deployed to a large variety of audio standards (Max/MSP externals, PD externals, VST plugins, CoreAudio applications, Jack applications, iPhone, etc.).

The architecture to be used is specified at compile time with the `-a` options. For example `faust -a jack-gtk.cpp foo.dsp` indicates to use the Jack GTK architecture when compiling `foo.dsp`.

The main available architecture files are listed table 5.1. Since FAUST 0.9.40 some of these architectures are a modular combination of an *audio module* and one or more *user interface modules*. Among these user interface modules OSCUI provide supports for Open Sound Control allowing FAUST programs to be controlled by OSC messages.

### 5.1 Audio architecture modules

An *audio architecture module* typically connects a FAUST program to the audio drivers. It is responsible for allocating and releasing the audio channels and for calling the FAUST `dsp::compute` method to handle incoming audio buffers and/or to produce audio output. It is also responsible for presenting the audio as non-interleaved float data, normalized between -1.0 and 1.0.

A FAUST audio architecture module derives an *audio* class defined as below:

```
class audio {
public:
    audio() {}
    virtual ~audio() {}
    virtual bool init(const char*, dsp*) = 0;
    virtual bool start() = 0;
    virtual void stop() = 0;
```

File name	Description
alchemy-as.cpp	Flash - ActionScript plugin
ca-qt.cpp	CoreAudio QT4 standalone application
jack-gtk.cpp	Jack GTK standalone application
jack-qt.cpp	Jack QT4 standalone application
jack-console.cpp	Jack command line application
jack-internal.cpp	Jack server plugin
alsa-gtk.cpp	ALSA GTK standalone application
alsa-qt.cpp	ALSA QT4 standalone application
oss-gtk.cpp	OSS GTK standalone application
pa-gtk.cpp	PortAudio GTK standalone application
pa-qt.cpp	PortAudio QT4 standalone application
max-msp.cpp	Max/MSP external
vst.cpp	VST plugin
vst2p4.cpp	VST 2.4 plugin
vsti-mono.cpp	VSTi mono instrument
ladspa.cpp	LADSPA plugin
q.cpp	Q language plugin
supercollider.cpp	SuperCollider Unit Generator
snd-rt-gtk.cpp	Snd-RT music programming language
csound.cpp	CSOUND opcode
puredata.cpp	PD external
sndfile.cpp	sound file transformation command
bench.cpp	speed benchmark
octave.cpp	Octave plugin
plot.cpp	Command line application
sndfile.cpp	Command line application

Table 5.1: Available architectures.

```
};
```

The API is simple enough to give a great flexibility to audio architectures implementations. The `init` method should initialize the audio. At `init` exit, the system should be in a safe state to recall the `dsp` object state.

Table 5.2 gives the audio architectures currently available for various operating systems.

Audio system	Operating system
Alsa	Linux
Core audio	Mac OS X, iOS
Jack	Linux, Mac OS X, Windows
Portaudio	Linux, Mac OS X, Windows
OSC (see 5.3.3)	Linux, Mac OS X, Windows
VST	Mac OS X, Windows
Max/MSP	Mac OS X, Windows
CSound	Linux, Mac OS X, Windows
SuperCollider	Linux, Mac OS X, Windows
PureData	Linux, Mac OS X, Windows
Pure [?]	Linux, Mac OS X, Windows

Table 5.2: FAUST audio architectures.

## 5.2 UI architecture modules

A UI architecture module links user actions (via graphic widgets, command line parameters, OSC messages, etc.) with the FAUST program to control. It is responsible for associating program parameters to user interface elements and to update parameter's values according to user actions. This association is triggered by the `dsp::buildUserInterface` call, where the `dsp` asks a UI object to build the DSP module controllers.

Since the interface is basically graphic oriented, the main concepts are *widget* based: a UI architecture module is semantically oriented to handle active widgets, passive widgets and widgets layout.

A FAUST UI architecture module derives an *UI* class (Figure 5.1).

### 5.2.1 Active widgets

Active widgets are graphical elements that control a parameter value. They are initialized with the widget name and a pointer to the linked value. The widget currently considered are `Button`, `ToggleButton`, `CheckButton`, `VerticalSlider`, `HorizontalSlider` and `NumEntry`.

A GUI architecture must implement a method `addXxx (const char* name, float* zone, ...)` for each active widget. Additional parameters are available for `Slider` and `NumEntry`: the `init` value, the `min` and `max` values and the `step`.

```

class UI
{
public:
    UI() {}
    virtual ~UI() {}

    -- active widgets
    virtual void addButton(const char* l, float* z) = 0;
    virtual void addToggleButton(const char* l, float* z) = 0;
    virtual void addCheckButton(const char* l, float* z) = 0;

    virtual void addVerticalSlider(const char* l, float* z,
        float init, float min, float max, float step) = 0;

    virtual void addHorizontalSlider(const char* l, float* z,
        float init, float min, float max, float step) = 0;

    virtual void addNumEntry(const char* l, float* z,
        float init, float min, float max, float step) = 0;

    -- passive widgets
    virtual void addNumDisplay(const char* l, float* z,
        int p) = 0;

    virtual void addTextDisplay(const char* l, float* z,
        const char* names[], float min, float max) = 0;

    virtual void addHorizontalBargraph(const char* l,
        float* z, float min, float max) = 0;

    virtual void addVerticalBargraph(const char* l,
        float* z, float min, float max) = 0;

    -- widget layouts
    virtual void openTabBox(const char* l) = 0;
    virtual void openHorizontalBox(const char* l) = 0;
    virtual void openVerticalBox(const char* l) = 0;
    virtual void closeBox() = 0;

    -- metadata declarations
    virtual void declare(float*, const char*, const char* ) {}
};

```

Figure 5.1: UI, the root user interface class.



### 5.2.2 Passive widgets

Passive widgets are graphical elements that reflect values. Similarly to active widgets, they are initialized with the widget name and a pointer to the linked value. The widget currently considered are `NumDisplay`, `TextDisplay`, `HorizontalBarGraph` and `VerticalBarGraph`.

A UI architecture must implement a method

`addxxx (const char* name, float* zone, ...)` for each passive widget. Additional parameters are available, depending on the passive widget type.

### 5.2.3 Widgets layout

Generally, a GUI is hierarchically organized into boxes and/or tab boxes. A UI architecture must support the following methods to setup this hierarchy :

```
openTabBox (const char* label)
openHorizontalBox (const char* label)
openVerticalBox (const char* label)
closeBox (const char* label)
```

Note that all the widgets are added to the current box.

### 5.2.4 Metadata

The FAUST language allows widget labels to contain metadata enclosed in square brackets. These metadata are handled at GUI level by a `declare` method taking as argument, a pointer to the widget associated zone, the metadata key and value:

```
declare(float* zone, const char* key, const char* value)
```

UI	Comment
console	a textual command line UI
GTK	a GTK-based GUI
Qt	a multi-platform Qt-based GUI
FUI	a file-based UI to store and recall modules states
OSC	OSC control (see 5.3.1)

Table 5.3: Available UI architectures.

## 5.3 OSC architecture modules

The OSC [?] support opens FAUST application's control to any OSC capable application or programming language. It also transforms a full range of devices embedding sensors (wiimote, smart phones, ...) into physical interfaces for FAUST application's control, allowing a direct use like musical instruments.

The FAUST OSC architecture is twofold: it is declined as a UI architecture and also as an audio architecture, proposing a new and original way to make digital signal computation.

### 5.3.1 OSC GUI architecture module

The OSC UI architecture transforms each UI active widget addition into an `addnode` call, ignores the passive widgets and transforms container calls (`openXxxBox`, `closeBox`) into `opengroup` and `closegroup` calls.

#### OSC address space and messages

The OSC address space adheres strictly to the hierarchy defined by the `addnode` and `opengroup`, `closegroup` calls. It supports the OSC pattern matching mechanism as described in [?].

A node expects to receive OSC messages with a single float value as parameter. This policy is strict for the parameters count, but relaxed for the parameter type: OSC int values are accepted and casted to float.

Audio system	Environment	OSC support
<i>Linux</i>		
Alsa	GTK, Qt	yes
Jack	GTK, Qt, Console	yes
PortAudio	GTK, Qt	yes
<i>Mac OS X</i>		
CoreAudio	Qt	yes
Jack	Qt, Console	yes
PortAudio	Qt	yes
<i>Windows</i>		
Jack	Qt, Console	yes
PortAudio	Qt	yes
<i>iOS (iPhone)</i>		
CoreAudio	Cocoa	not yet

Table 5.4: OSC support in FAUST application's architectures.

Two additional messages are defined to provide FAUST applications discovery and address space discoveries:

- the `hello` message: accepted by any module root address. The module responds with its root address, followed by its IP address and the UDP port numbers (listening port, output port, error port). See the network management section below for ports numbering scheme.
- the `get` message: accepted by any valid OSC address. The `get` message is propagated to every terminal node that responds with its OSC address and current values (value, min and max).

#### Example:

Consider the `noise` module provided with the FAUST examples:

- it sends `/noise 192.168.0.1 5510 5511 5512` in answer to a `hello` message,

- it sends `/noise/Volume 0.8 0. 1.` in answer to a `get` message.

### Network management.

The OSC module makes use of three different UDP port numbers:

- 5510 is the listening port number: control messages should be addressed to this port.
- 5511 is the output port number: answers to query messages are sent to this port.
- 5512 is the error port number: used for asynchronous error notifications.

When the UDP listening port number is busy (for instance in case of multiple FAUST programs running), the system automatically looks for the next available port number. Unless otherwise specified by the command line, the UDP output port numbers are unchanged.

A program sends its name (actually its root address) and allocated port numbers on the OSC output port on startup.

Port numbers can be changed on the command line with the following options:

```
[-port | -outport | -errport] number
```

The default UDP output streams destination is `localhost`. It can also be changed with the command line option

```
-dest address where address is a host name or an IP number.
```

### 5.3.2 OSC message aliases

Alias is a metadata-based mechanism allowing to map arbitrary incoming OSC messages to program parameters. Some remote controllers, like TouchOSC on Android, can only transmit predefined messages, for example `/1/push1 1.000000` when push button 1 is pressed, `/accxyz -0.421380 0.268151 9.232041` for the x, y and z accelerometers, `/1/fader1 0.563994` when fader 1 is moved, etc.

Such messages can be used to control a specific program parameter by inserting an OSC metadata `[osc:/path/name]` in its label. For example `vslider("Volume", 0, 0, 1, 0.1)` can be controlled by TouchOSC fader 1 by indicating its OSC address: `vslider("Volume[osc:/1/fader1]", 0, 0, 1, 0.1)` (see table 5.5 for a more complete list of aliases).

By default the incoming value range is assumed to be between 0 and 1. But it is possible to indicate a different range: `[osc:/path/name min max]`. When incoming messages provide more than one value it is possible to select the right one with an additional suffix (numbered starting from 0) to the pathname. For instance `vslider("Volume[osc:/accxyz/1 -10 10]", 0, 0, 1, 0.1)` would allow to control the volume using the y accelerometer. Moreover the accelerometer's values are mapped from range `[-10..10]` to range `[0..1]`.

alias	description
[osc:/1/rotary1]	top left rotary knob
[osc:/1/rotary2]	middle left rotary knob
[osc:/1/rotary3]	bottom left rotary knob
[osc:/1/push1]	bottom left push button
[osc:/1/push2]	bottom center left push button
[osc:/1/toggle1]	top center left toggle button
[osc:/1/toggle2]	middle center left toggle button
[osc:/1/fader1]	center left vertical fader
[osc:/1/toggle3]	top center right toggle button
[osc:/1/toggle4]	middle center right toggle button
[osc:/1/fader2]	center right vertical toggle button
[osc:/1/rotary4]	top right rotary knob
[osc:/1/rotary5]	middle right rotary knob
[osc:/1/rotary6]	bottom right rotary knob
[osc:/1/push3]	bottom center right push button
[osc:/1/push4]	bottom right push button
[osc:/1/fader3]	bottom horizontal fader
[osc:/accxyz/0 -10 10]	x accelerometer
[osc:/accxyz/1 -10 10]	y accelerometer
[osc:/accxyz/2 -10 10]	z accelerometer

Table 5.5: Examples of OSC message aliases for TouchOSC (layout Mix2). Since most of these messages produce values in the default range  $[0..1]$ , there is no need to indicate this range. Accelerometers producing values in a different range, this range  $[-10..10]$  has to be indicated.

### 5.3.3 OSC audio architecture

The OSC audio architecture implements an audio architecture where audio inputs and outputs are replaced by OSC messages. Using this architecture, a FAUST module accepts arbitrary data streams on its root OSC address, and handles this input stream as interleaved signals. Thus, each incoming OSC packet addressed to a module root triggers a computation loop, where as many values as the number of incoming frames are computed.

The output of the signal computation is sent to the OSC output port as non-interleaved data to the OSC addresses `/root/n` where `root` is the module root address and `n` is the output number (indexed from 0).

For example:

consider a FAUST program named *split* and defined by:

```
process = _ <: _,_
```

the message

```
/split 0.3
```

will produce the 2 following messages as output:

```
/split/0 0.3
```

```
/split/1 0.3
```

The OSC audio architecture provides a very convenient way to execute a signal processing at an arbitrary rate, even allowing to make step by step computation. Connecting the output OSC signals to Max/MSP or to a system like INScore<sup>1</sup>[], provides a close examination of the computation results.

---

<sup>1</sup><http://inscore.sf.net>



## Chapter 6

# Controlling the code generation

Several options of the FAUST compiler allow to control the generated C++ code. By default the computations are done sample by sample in a single loop. But the compiler can also generate *vector* and *parallel* code.

### 6.1 Vector Code generation

Modern C++ compilers are able to do autovectorization, that is to use SIMD instructions to speedup the code. These instructions can typically operate in parallel on short vectors of 4 simple precision floating point numbers thus leading to a theoretical speedup of  $\times 4$ . Autovectorization of C/C++ programs is a difficult task. Current compilers are very sensitive to the way the code is arranged. In particular too complex loops can prevent autovectorization. The goal of the vector code generation is to rearrange the C++ code in a way that facilitates the autovectorization job of the C++ compiler. Instead of generating a single sample computation loop, it splits the computation into several simpler loops that communicates by vectors.

The vector code generation is activated by passing the `--vectorize` (or `-vec`) option to the FAUST compiler. Two additional options are available: `--vec-size <n>` controls the size of the vector (by default 32 samples) and `--loop-variant 0/1` gives some additional control on the loops.

To illustrate the difference between scalar code and vector code, let's take the computation of the RMS (Root Mean Square) value of a signal. Here is the FAUST code that computes the Root Mean Square of a sliding window of 1000 samples:

```
// Root Mean Square of n consecutive samples
RMS(n) = square : mean(n) : sqrt ;

// Square of a signal
square(x) = x * x ;
```

```

// Mean of n consecutive samples of a signal
// (uses fixpoint to avoid the accumulation of
// rounding errors)
mean(n) = float2fix : integrate(n) :
          fix2float : /(n);

// Sliding sum of n consecutive samples
integrate(n,x) = x - x@n : +~_ ;

// Conversion between float and fix point
float2fix(x) = int(x*(1<<20));
fix2float(x) = float(x)/(1<<20);

// Root Mean Square of 1000 consecutive samples
process = RMS(1000) ;

```

The compute() method generated in scalar mode is the following:

```

virtual void compute (int count,
                     float** input,
                     float** output)
{
    float* input0 = input[0];
    float* output0 = output[0];
    for (int i=0; i<count; i++) {
        float fTemp0 = input0[i];
        int iTemp1 = int(1048576*fTemp0*fTemp0);
        iVec0[IOTA&1023] = iTemp1;
        iRec0[0] = ((iVec0[IOTA&1023] + iRec0[1])
                   - iVec0[(IOTA-1000)&1023]);
        output0[i] = sqrtf(9.536744e-10f *
                           float(iRec0[0]));

        // post processing
        iRec0[1] = iRec0[0];
        IOTA = IOTA+1;
    }
}

```

The -vec option leads to the following reorganization of the code:

```

virtual void compute (int fullcount,
                     float** input,
                     float** output)
{
    int iRec0_tmp[32+4];
    int* iRec0 = &iRec0_tmp[4];
    for (int index=0; index<fullcount; index+=32)
    {
        int count = min (32, fullcount-index);
        float* input0 = &input[0][index];
        float* output0 = &output[0][index];
    }
}

```



```

for (int i=0; i<4; i++)
    iRec0_tmp[i]=iRec0_perm[i];
// SECTION : 1
for (int i=0; i<count; i++) {
    iYec0[(iYec0_idx+i)&2047] =
        int(1048576*input0[i]*input0[i]);
}
// SECTION : 2
for (int i=0; i<count; i++) {
    iRec0[i] = ((iYec0[i] + iRec0[i-1]) -
        iYec0[(iYec0_idx+i-1000)&2047]);
}
// SECTION : 3
for (int i=0; i<count; i++) {
    output0[i] = sqrtf((9.536744e-10f *
        float(iRec0[i])));
}
// SECTION : 4
iYec0_idx = (iYec0_idx+count)&2047;
for (int i=0; i<4; i++)
    iRec0_perm[i]=iRec0_tmp[count+i];
}
}

```

While the second version of the code is more complex, it turns out to be much easier to vectorize efficiently by the C++ compiler. Using Intel icc 11.0, with the exact same compilation options: `-O3 -xHost -ftz -fno-alias -fp-model fast=2`, the scalar version leads to a throughput performance of 129.144 MB/s, while the vector version achieves 359.548 MB/s, a speedup of x2.8 !

The vector code generation is built on top of the scalar code generation (see figure 6.1). Every time an expression needs to be compiled, the compiler checks if it requires a separate loop or not. It applies some simple rules for that. Expressions that are shared (and are complex enough) are good candidates to be compiled in a separate loop, as well as recursive expressions and expressions used in delay lines.

The result is a directed graph in which each node is a computation loop (see Figure 6.2). This graph is stored in the class object and a topological sort is applied to it before printing the code.

## 6.2 Parallel Code generation

The parallel code generation is activated by passing either the `--openMP` (or `-omp`) option or the `--scheduler` (or `-sch`) option. It implies the `-vec` options as the parallel code generation is built on top of the vector code generation.

### 6.2.1 The OpenMP code generator

The `--openMP` (or `-omp`) option given to the FAUST compiler will insert appropriate OpenMP directives in the C++ code. OpenMP (<http://www.openmp.org>) is

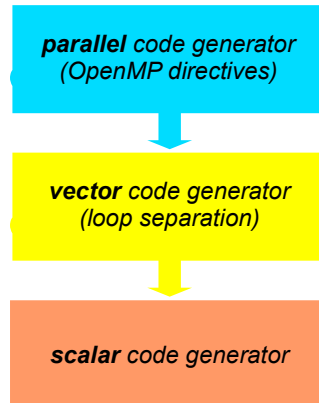

Figure 6.1: FAUST’s stack of code generators

a well established API that is used to explicitly define direct multi-threaded, shared memory parallelism. It is based on a fork-join model of parallelism (see figure 6.3). Parallel regions are delimited by `#pragma omp parallel` constructs. At the entrance of a parallel region a team of parallel threads is activated. The code within a parallel region is executed by each thread of the parallel team until the end of the region.

```

#pragma omp parallel
{
  // the code here is executed simultaneously by
  // every thread of the parallel team
  ...
}
  
```

In order not to have every thread doing redundantly the exact same work, OpenMP provides specific *work-sharing* directives. For example `#pragma omp sections` allows to break the work into separate, discrete sections, each section being executed by one thread:

```

#pragma omp parallel
{
  #pragma omp sections
  {
    #pragma omp section
    {
      // job 1
    }
    #pragma omp section
    {
  
```

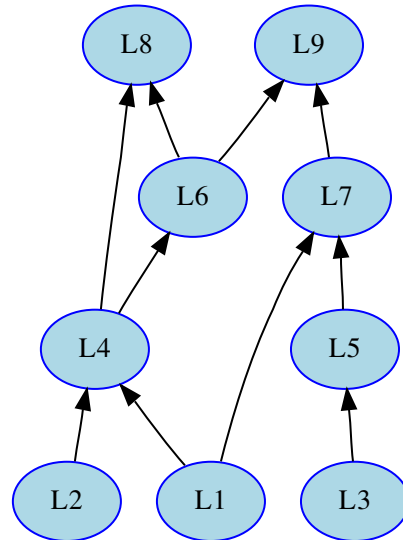

Figure 6.2: The result of the `-vec` option is a directed acyclic graph (DAG) of small computation loops

```

    // job 2
    }
    ...
}
...
}

```

### 6.2.2 Adding OpenMP directives

As said before the parallel code generation is built on top of the vector code generation. The graph of loops produced by the vector code generator is topologically sorted in order to detect the loops that can be computed in parallel. The first set  $S_0$  (loops  $L1$ ,  $L2$  and  $L3$  in the DAG of Figure 6.2) contains the loops that don't depend on any other loops, the set  $S_1$  contains the loops that only depend on loops of  $S_0$ , (that is loops  $L4$  and  $L5$ ), etc..

As all the loops of a given set  $S_n$  can be computed in parallel, the compiler will generate a `sections` construct with a `section` for each loop.

```

#pragma omp sections
{
    #pragma omp section

```

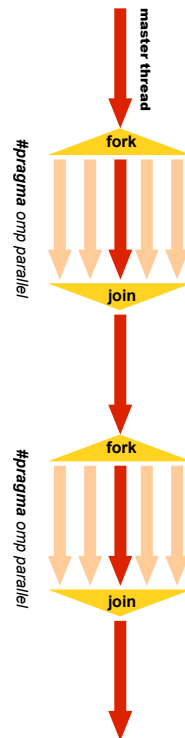

Figure 6.3: OpenMP is based on a fork-join model

```

for (...) {
    // Loop 1
}
#pragma omp section
for (...) {
    // Loop 2
}
...
}

```

If a given set contains only one loop, then the compiler checks to see if the loop can be parallelized (no recursive dependencies) or not. If it can be parallelized, it generates:

```

#pragma omp for
for (...) {
    // Loop code
}

```

otherwise it generates a `single` construct so that only one thread will execute the loop:

```

#pragma omp single
for (...) {
    // Loop code
}

```

```
}

```

### 6.2.3 Example of parallel OpenMP code

To illustrate how FAUST uses the OpenMP directives, here is a very simple example, two 1-pole filters in parallel connected to an adder (see figure 6.4 the corresponding block-diagram):

```
filter(c) = *(1-c) : + ~ *(c);
process = filter(0.9), filter(0.9) : +;
```

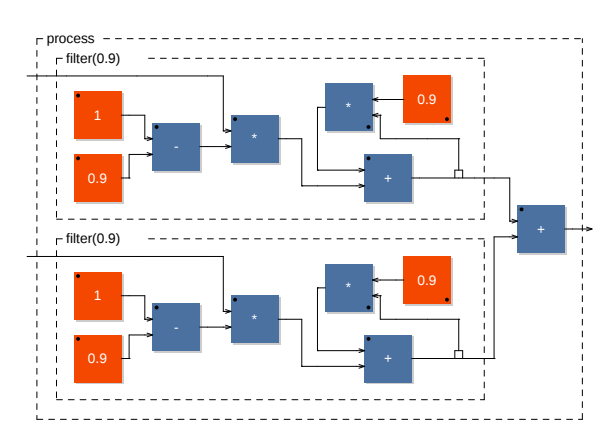

Figure 6.4: two filters in parallel connected to an adder

The corresponding compute() method obtained using the -omp option is the following:

```
virtual void compute (int fullcount,
                    float** input,
                    float** output)
{
    float    fRec0_tmp[32+4];
    float    fRec1_tmp[32+4];
    float*   fRec0 = &fRec0_tmp[4];
    float*   fRec1 = &fRec1_tmp[4];
    #pragma omp parallel firstprivate(fRec0, fRec1)
    {
        for (int index = 0; index < fullcount;
            index += 32)
        {
            int count = min (32, fullcount-index);
            float* input0 = &input[0][index];
            float* input1 = &input[1][index];
            float* output0 = &output[0][index];
            #pragma omp single
```

```

{
  for (int i=0; i<4; i++)
    fRec0_tmp[i]=fRec0_perm[i];
  for (int i=0; i<4; i++)
    fRec1_tmp[i]=fRec1_perm[i];
}
// SECTION : 1
#pragma omp sections
{
  #pragma omp section
  for (int i=0; i<count; i++) {
    fRec0[i] = ((0.1f * input1[i])
               + (0.9f * fRec0[i-1]));
  }
  #pragma omp section
  for (int i=0; i<count; i++) {
    fRec1[i] = ((0.1f * input0[i])
               + (0.9f * fRec1[i-1]));
  }
}
// SECTION : 2
#pragma omp for
for (int i=0; i<count; i++) {
  output0[i] = (fRec1[i] + fRec0[i]);
}
// SECTION : 3
#pragma omp single
{
  for (int i=0; i<4; i++)
    fRec0_perm[i]=fRec0_tmp[count+i];
  for (int i=0; i<4; i++)
    fRec1_perm[i]=fRec1_tmp[count+i];
}
}
}
}

```

This code requires some comments:

1. The parallel construct `#pragma omp parallel` is the fundamental construct that starts parallel execution. The number of parallel threads is generally the number of CPU cores but it can be controlled in several ways.
2. Variables external to the parallel region are shared by default. The pragma `firstprivate(fRec0, fRec1)` indicates that each thread should have its private copy of `fRec0` and `fRec1`. The reason is that accessing shared variables requires an indirection and is quite inefficient compared to private copies.
3. The top level loop `for (int index = 0; ...)` is executed by all threads simultaneously. The subsequent work-sharing directives inside the loop will indicate how the work must be shared between the threads.

4. Please note that an implied barrier exists at the end of each work-sharing region. All threads must have executed the barrier before any of them can continue.
5. The work-sharing directive `#pragma omp single` indicates that this first section will be executed by only one thread (any of them).
6. The work-sharing directive `#pragma omp sections` indicates that each corresponding `#pragma omp section`, here our two filters, will be executed in parallel.
7. The loop construct `#pragma omp for` specifies that the iterations of the associated loop will be executed in parallel. The iterations of the loop are distributed across the parallel threads. For example, if we have two threads, the first one can compute indices between 0 and  $\text{count}/2$  and the other one between  $\text{count}/2$  and  $\text{count}$ .
8. Finally `#pragma omp single` in section 3 indicates that this last section will be executed by only one thread (any of them).

#### 6.2.4 The scheduler code generator

With the `--scheduler` (or `-sch`) option given to the FAUST compiler, the computation graph is cut into separated computation loops (called "tasks"), and a "Work Stealing Scheduler" is used to activate and execute them following their dependencies. A pool of worked threads is created and each thread uses its own local WSQ (Work Stealing Queue) of tasks. A WSQ is a special queue with a Push operation, a "private" LIFO Pop operation and a "public" FIFO Pop operation.

Starting from a ready task, each thread follows the dependencies, possibly pushing ready sub-tasks into its own local WSQ. When no more tasks can be activated on a given computation path, the thread pops a task from its local WSQ. If the WSQ is empty, then the thread is allowed to "steal" tasks from other threads WSQ.

The local LIFO Pop operation allows better cache locality and the FIFO steal Pop "larger chunk" of work to be done. The reason for this is that many work stealing workloads are divide-and-conquer in nature, stealing one of the oldest task implicitly also steals a (potentially) large subtree of computations that will unfold once that piece of work is stolen and run.

Compared to the OpenMP model (`-omp`) the new model is worse for simple FAUST programs and usually starts to behave comparable or sometimes better for "complex enough" FAUST programs. In any case, since OpenMP does not behave so well with GCC compilers (only quite recent versions like GCC 4.4 start to show some improvements), and is unusable on OSX in real-time contexts, this new scheduler option has its own value. We plan to improve it adding a "pipelining" idea in the future.

#### 6.2.5 Example of parallel scheduler code

To illustrate how FAUST generates the scheduler code, here is a very simple example, two 1-pole filters in parallel connected to an adder (see figure 6.4 the corresponding block-diagram):

```

filter(c) = *(1-c) : + ~ *(c);
process = filter(0.9), filter(0.9) : +;

```

When `-sch` option is used, the content of the additional `architecture/scheduler.b` file is inserted in the generated code. It contains code to deal with WSQ and thread management. The `compute()` and `computeThread()` methods are the following:

```

virtual void compute (int fullcount,
                    float** input,
                    float** output)
{
    GetRealTime();
    this->input = input;
    this->output = output;
    StartMeasure();
    for (fIndex = 0; fIndex < fullcount; fIndex += 32) {
        fFullCount = min (32, fullcount-fIndex);
        TaskQueue::Init();
        // Initialize end task
        fGraph.InitTask(1,1);
        // Only initialize tasks with inputs
        fGraph.InitTask(4,2);
        fIsFinished = false;
        fThreadPool.SignalAll(fDynamicNumThreads - 1);
        computeThread(0);
        while (!fThreadPool.IsFinished()) {}
    }
    StopMeasure(fStaticNumThreads,
               fDynamicNumThreads);
}

void computeThread (int cur_thread) {
    float* fRec0 = &fRec0_tmp[4];
    float* fRec1 = &fRec1_tmp[4];
    // Init graph state
    {
        TaskQueue taskqueue;
        int tasknum = -1;
        int count = fFullCount;
        // Init input and output
        FAUSTFLOAT* input0 = &input[0][fIndex];
        FAUSTFLOAT* input1 = &input[1][fIndex];
        FAUSTFLOAT* output0 = &output[0][fIndex];
        int task_list_size = 2;
        int task_list[2] = {2,3};
        taskqueue.InitTaskList(task_list_size, task_list
                               , fDynamicNumThreads, cur_thread, tasknum);
        while (!fIsFinished) {
            switch (tasknum) {
                case WORK_STEALING_INDEX: {

```



```

        tasknum = TaskQueue::GetNextTask(
            cur_thread);
        break;
    }
    case LAST_TASK_INDEX: {
        fIsFinished = true;
        break;
    }
    // SECTION : 1
    case 2: {
        // LOOP 0x101111680
        // pre processing
        for (int i=0; i<4; i++) fRec0_tmp[i]
            =fRec0_perm[i];
        // exec code
        for (int i=0; i<count; i++) {
            fRec0[i] = ((1.000000e-01f * (
                float)input1[i]) + (0.9f *
                fRec0[i-1]));
        }
        // post processing
        for (int i=0; i<4; i++) fRec0_perm[i]
            =fRec0_tmp[count+i];

        fGraph.ActivateOneOutputTask(
            taskqueue, 4, tasknum);
        break;
    }
    case 3: {
        // LOOP 0x10111125e0
        // pre processing
        for (int i=0; i<4; i++) fRec1_tmp[i]
            =fRec1_perm[i];
        // exec code
        for (int i=0; i<count; i++) {
            fRec1[i] = ((1.000000e-01f * (
                float)input0[i]) + (0.9f *
                fRec1[i-1]));
        }
        // post processing
        for (int i=0; i<4; i++) fRec1_perm[i]
            =fRec1_tmp[count+i];

        fGraph.ActivateOneOutputTask(
            taskqueue, 4, tasknum);
        break;
    }
    case 4: {
        // LOOP 0x101111580
        // exec code

```

```
        for (int i=0; i<count; i++) {
            output0[i] = (FAUSTFLOAT)(fRec1[
                i] + fRec0[i]);
        }

        tasknum = LAST_TASK_INDEX;
        break;
    }
}
}
```

## Chapter 7

# Mathematical Documentation

The FAUST compiler provides a mechanism to produce a self-describing documentation of the mathematical semantic of a FAUST program, essentially as a pdf file. The corresponding options are `-mdoc` (short) or `--mathdoc` (long).

### 7.1 Goals of the mathdoc

There are three main goals, or uses, of this mathematical documentation:

1. to preserve signal processors, independently from any computer language but only under a mathematical form;
2. to bring some help for debugging tasks, by showing the formulas as they are really computed after the compilation stage;
3. to give a new teaching support, as a bridge between code and formulas for signal processing.

### 7.2 Installation requirements

- `faust`, of course!
- `svg2pdf` (from the Cairo 2D graphics library), to convert block-diagrams, as  $\LaTeX$  doesn't eat SVG directly yet...
- `breqn`, a  $\LaTeX$  package to handle automatic breaking of long equations,
- `pdflatex`, to compile the  $\LaTeX$  output file.

## 7.3 Generating the mathdoc

The easiest way to generate the complete mathematical documentation is to call the `faust2mathdoc` script on a FAUST file, as the `-mdoc` option leave the documentation production unfinished. For example:

```
faust2mathdoc noise.dsp
```

### 7.3.1 Invoking the `-mdoc` option

Calling directly `faust -mdoc` does only the first part of the work, generating:

- a top-level directory, suffixed with `"-mdoc"`,
- 5 subdirectories (`cpp/`, `pdf/`, `src/`, `svg/`, `tex/`),
- a  $\text{\LaTeX}$  file containing the formulas,
- SVG files for block-diagrams.

At this stage:

- `cpp/` remains empty,
- `pdf/` remains empty,
- `src/` contains all FAUST sources used (even libraries),
- `svg/` contains SVG block-diagram files,
- `tex/` contains the generated  $\text{\LaTeX}$  file.

### 7.3.2 Invoking `faust2mathdoc`

The `faust2mathdoc` script calls `faust --mathdoc` first, then it finishes the work:

- moving the output C++ file into `cpp/`,
- converting all SVG files into pdf files (you must have `svg2pdf` installed, from the Cairo 2D graphics library),
- launching `pdflatex` on the  $\text{\LaTeX}$  file (you must have both `pdflatex` and the `breqn` package installed),
- moving the resulting pdf file into `pdf/`.

### 7.3.3 Online examples

To get an idea of the results of this mathematical documentation, which captures the mathematical semantic of FAUST programs, you can look at two pdf files online:

- <http://faust.grame.fr/pdf/karplus.pdf> (automatic documentation),
- <http://faust.grame.fr/pdf/noise.pdf> (manual documentation).

You can also generate all *mdoc* pdfs at once, simply invoking the `make mathdoc` command inside the `examples/` directory:

- for each `%.dsp` file, a complete `%-mdoc` directory will be generated,
- a single `allmathpdfs/` directory will gather all the generated pdf files.

## 7.4 Automatic documentation

By default, when no `<mdoc>` tag can be found in the input FAUST file, the `-mdoc` option automatically generates a L<sup>A</sup>T<sub>E</sub>X file with four sections:

1. "Equations of process", gathering all formulas needed for `process`,
2. "Block-diagram schema of process", showing the top-level block-diagram of `process`,
3. "Notice of this documentation", summing up generation and conventions information,
4. "Complete listing of the input code", listing all needed input files (including libraries).

## 7.5 Manual documentation

You can specify yourself the documentation instead of using the automatic mode, with five xml-like tags. That permits you to modify the presentation and to add your own comments, not only on `process`, but also about any expression you'd like to. Note that as soon as you declare an `<mdoc>` tag inside your FAUST file, the default structure of the automatic mode is ignored, and all the L<sup>A</sup>T<sub>E</sub>X stuff becomes up to you!

### 7.5.1 Six tags

Here are the six specific tags:

- `<mdoc></mdoc>`, to open a documentation field in the FAUST code,
  - `<equation></equation>`, to get equations of a FAUST expression,

- `<diagram></diagram>`, to get the top-level block-diagram of a FAUST expression,
- `<metadata></metadata>`, to reference FAUST metadatas (cf. declarations), calling the corresponding keyword,
- `<notice />`, to insert the "adaptive" notice all formulas actually printed,
- `<listing [attributes] />`, to insert the listing of FAUST files called.

The `<listing />` tag can have up to three boolean attributes (set to "true" by default):

- `mdoctags` for `<mdoc>` tags;
- `dependencies` for other files dependencies;
- `distributed` for the distribution of interleaved FAUST code between `<mdoc>` sections.

## 7.5.2 The mdoc top-level tags

The `<mdoc></mdoc>` tags are the top-level delimiters for FAUST mathematical documentation sections. This means that the four other documentation tags can't be used outside these pairs (see section 3.2.3).

In addition of the four inner tags, `<mdoc></mdoc>` tags accept free L<sup>A</sup>T<sub>E</sub>X text, including its standard macros (like `\section`, `\emph`, etc.). This allows to manage the presentation of resulting tex file directly from within the input FAUST file.

The complete list of the L<sup>A</sup>T<sub>E</sub>X packages included by FAUST can be found in the file `architecture/latexheader.tex`.

## 7.5.3 An example of manual mathdoc

```

<mdoc>
\title{<metadata>name</metadata>}
\author{<metadata>author</metadata>}
\date{\today}
\maketitle

\begin{tabular}{ll}
\hline
\textbf{name} & <metadata>name</metadata> \\
\textbf{version} & <metadata>version</metadata> \\
\textbf{author} & <metadata>author</metadata> \\
\textbf{license} & <metadata>license</metadata> \\
\textbf{copyright} & <metadata>copyright</metadata> \\
\hline
\end{tabular}
\bigskip
</mdoc>
//-----
// Noise generator and demo file for the Faust math documentation
//-----

declare name "Noise";

```

```

declare version      "1.1";
declare author       "Grame";
declare author       "Yghe";
declare license      "BSD";
declare copyright    "(c)GRAME 2009";

<mdoc>
\section{Presentation of the "noise.dsp" Faust program}
This program describes a white noise generator with an interactive
  volume, using a random function.

\subsection{The random function}
</mdoc>

random = +(12345)~*(1103515245);

<mdoc>
The \texttt{random} function describes a generator of random numbers,
  which equation follows. You should notice hereby the use of an
  integer arithmetic on 32 bits, relying on integer wrapping for
  big numbers.
<equation>random</equation>

\subsection{The noise function}
</mdoc>

noise = random/2147483647.0;

<mdoc>
The white noise then corresponds to:
<equation>noise</equation>

\subsection{Just add a user interface element to play volume!}
</mdoc>

process = noise * vslider("Volume[style:knob]", 0, 0, 1, 0.1);

<mdoc>
Endly, the sound level of this program is controlled by a user slider
  , which gives the following equation:
<equation>process</equation>

\section{Block-diagram schema of process}
This process is illustrated on figure 1.
<diagram>process</diagram>

\section{Notice of this documentation}
You might be careful of certain information and naming conventions
  used in this documentation:
<notice />

\section{Listing of the input code}
The following listing shows the input Faust code, parsed to compile
  this mathematical documentation.
<listing mdoctags="false" dependencies="false" distributed="true" />
</mdoc>

```

The following page which gathers the four resulting pages of `noise.pdf` in small size, might give you an idea of the produced documentation.

### 7.5.4 The `-stripdoc` option

As you can see on the resulting file `noisemetadata.pdf` on its pages 3 and 4, the listing of the input code (section 4) contains all the `mathdoc` text (here colored in grey). As it may be useless in certain cases (see Goals, section 7.1), we provide an option to strip `mathdoc` contents directly at compilation stage: `-stripdoc` (short) or `--strip-mdoc-tags` (long).

## 7.6 Localization of `mathdoc` files

By default, texts used by the documentator are in English, but you can specify another language (French, German and Italian for the moment), using the `-mdlangu` (or `--mathdoc-lang`) option with a two-letters argument (`en`, `fr`, `it`, etc.).

The `faust2mathdoc` script also supports this option, plus a third short form with `-l`:

```
faust2mathdoc -l fr myfaustfile.dsp
```

If you would like to contribute to the localization effort, feel free to translate the `mathdoc` texts from any of the `mathdoctexts-*.txt` files, that are in the `architecture` directory (`mathdoctexts-fr.txt`, `mathdoctexts-it.txt`, etc.). As these files are dynamically loaded, just adding a new file with an appropriate name should work.



```

name      Noise
version   1.1
author    Gramme, Yeghe
license   BSD
copyright (c)GRAME 2009

```

Gramme, Yeghe  
March 9, 2010

## Noise

```

// Noise generator and demo file for the Faust math documentation
//-----
declare name      "noise";
declare version   "1.1";
declare author    "Gramme";
declare author    "Yeghe";
declare license   "BSD";
declare copyright "(C)GRAME 2009";

```

# 1 Presentation of the "noise.dsp" Faust program

This program describes a white noise generator with an interactive volume, using a random function.

## 1.1 The random function

```
random = *(int(12345))*(int(1098565245));
```

The random function describes a generator of random numbers, which equation follows. You should notice hereby the use of an integer arithmetic on 32 bits, relying on integer wrapping for big numbers.

1. Output signal  $y$  such that

$$y(t) = r_1(t)$$

2. Input signal (none)

3. Intermediate signal  $r_1$  such that

$$r_1(t) = 12345 \oplus 11098515245 \odot r_1(t-1)$$

## 1.2 The noise function

```
noise = (int(Random))/(int(Random+1));
```

The white noise then corresponds to:

1. Output signal  $y$  such that

$$y(t) = s_1(t)$$

2. Input signal (none)

3. Intermediate signal  $s_1$  such that

$$s_1(t) = \text{int}(r_1(t)) \odot \text{int}(1 \oplus r_1(t))$$

## 1.3 Just add a user interface element to play volume!

```
process = noise * vslider("volume[evjys:knob]", 0, 0, 1, 0.1);
```

Endly, the sound level of this program is controlled by a user slider, which gives the following equation:

1. Output signal  $y$  such that

$$y(t) = u_{s_1}(t) \cdot s_1(t)$$

2. Input signal (none)

3. User-interface input signal  $u_{s_1}$  such that

$$"Volume" \quad u_{s_1}(t) \in [0, 1] \quad (\text{default value} = 0)$$

## 2 Block-diagram schema of process

This process is illustrated on figure 1.

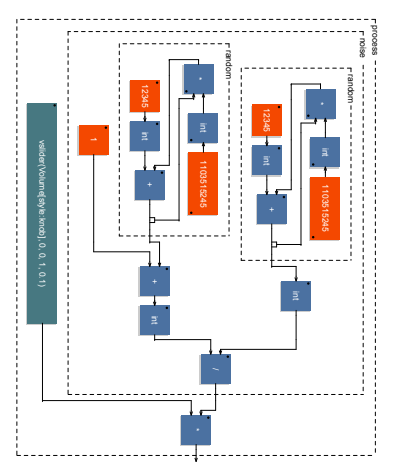

Figure 1: Block diagram of process

### 3 Notice of this documentation

You might be careful of certain information and naming conventions used in this documentation:

- This document was generated using Faust version (0.9.13 on March, 09, 2010).
- The value of a Faust program is the result of applying the signal transformer denoted by the expression to which the `process` identifier is bound to input signals, running at the  $f_s$  sampling frequency.
- Faust (*Functional Audio Stream*) is a functional programming language designed for synchronous real-time signal processing and synthesis applications. A Faust program is a set of bindings of identifiers to expressions that denote signal transformers. A signal  $s$  in  $S$  is a function mapping<sup>1</sup> times  $t \in \mathbb{Z}$  to values  $s(t) \in \mathbb{R}$ , while a signal transformer is a function

<sup>1</sup>Faust assumes that  $\forall s \in \text{SIGNAL} \mathbb{Z}, s(t) = 0$  when  $t < 0$ .

from  $S^n$  to  $S^m$ , where  $n, m \in \mathbb{N}$ . See the Faust manual for additional information (<http://faust-gate.fr>).

- Every mathematical formula derived from a Faust expression is assumed, in this document, to having been normalized (in an implementation-dependent manner) by the Faust compiler.
- A block diagram is a graphical representation of the Faust binding of an identifier `I` to an expression `E`: each graph is put in a box labeled by `I`. Subexpressions of `E` are recursively displayed as long as the whole picture fits in one page.

- $\forall x \in \mathbb{R}$ ,

$$\text{int}(x) = \begin{cases} \lfloor x \rfloor & \text{if } x > 0 \\ \lceil x \rceil & \text{if } x < 0 \\ 0 & \text{if } x = 0 \end{cases}$$

- This document uses the following integer operations:

operation	name	semantics
$i \oplus j$	Integer addition	$\text{normalize}(i + j)$ , in $\mathbb{Z}$
$i \odot j$	Integer multiplication	$\text{normalize}(i \cdot j)$ , in $\mathbb{Z}$
$i \oslash j$	Integer division	$\text{normalize}(\text{int}(i/j))$ , in $\mathbb{Q}$

Integer operations in Faust are inspired by the semantics of operations on the  $n$ -bit two's complement representation of integer numbers: they are internal composition laws on the subset  $[-2^{n-1}, 2^{n-1}-1]$  of  $\mathbb{Z}$ , with  $n = 32$ . For any integer binary operation  $\times$  on  $\mathbb{Z}$ , the  $\otimes$  operation is defined as:  $i \otimes j = \text{normalize}(i \times j)$ , with

$$\text{normalize}(i) = i - N \cdot \text{sign}(i) \cdot \left\lfloor \frac{|i| + N/2 + (\text{sign}(i) - 1)/2}{N} \right\rfloor,$$

where  $N = 2^n$  and  $\text{sign}(i) = 0$  if  $i = 0$  and  $i/|i|$  otherwise. Unary integer operations are defined likewise.

- The `noisemetadata-ndoc/` directory may also include the following sub-directories:
  - `cpp/` for Faust compiled code;
  - `pdf/` which contains this document;
  - `src/` for all Faust sources used (even libraries);
  - `svg/` for block diagrams, encoded using the Scalable Vector Graphics format (<http://www.w3.org/Graphics/SVG/>);
  - `tex/` for the LaTeX source of this document.

#### 4 Listing of the input code

The following listing shows the input Fortran code, passed to compile this mathematical documentation.

```
Listing 1: noise metadata.datp
1 //-----
2 //-----
3 //-----
4 declare name "Noise"
5 declare version "1.1"
6 declare author "Graham"
7 declare license "BSD"
8 declare copyright "(C)GAMMA 2009"
9
10 random = (int(2985)) * (int(110515285));
11
12
13 noise = (int(random))/(int(random));
14
15 process = noise * walter("olam(ryk-moh)", 0, 0, 1, 0.1);
16
17
18
```

## 7.7 Summary of the mathdoc generation steps

1. First, to get the full mathematical documentation done on your faust file, call `faust2mathdoc myfaustfile.dsp`.
2. Then, open the pdf file `myfaustfile-mdoc/pdf/myfaustfile.pdf`.
3. That's all !

## Chapter 8

# Acknowledgments

Many persons are contributing to the FAUST project, by providing code for the compiler, architecture files, libraries, examples, documentation, scripts, bug reports, ideas, etc. I would like in particular to thank:

- Fons Adriaensen
- Tiziano Bole
- Thomas Charbonnel
- Damien Cramet
- Étienne Gaudrin
- Albert Gräf
- Stefan Kersten
- Victor Lazzarini
- Matthieu Leberre
- Mathieu Leroi
- Kjetil Matheussen
- Rémy Muller
- Nicolas Scaringella
- Stephen Sinclair
- Travis Skare
- Julius Smith

Many developments of the FAUST project are now made within the ASTREE project (ANR 2008 CORD 003 02). I would like to thank my ASTREE's partners:

- Jérôme Barthélemy (IRCAM)
- Alain Bonardi (IRCAM)
- Raffaele Ciavarella (IRCAM)
- Pierre Jouvelot (École des Mines/ParisTech)
- Laurent Pottier (U. Saint-Etienne)

as well as my colleagues at GRAME, in particular : Dominique Fober, Stéphane Letz and Karim Barkati.

I would like also to thank for their financial support:

- the French Ministry of Culture
- the Rhône-Alpes Region
- the City of Lyon
- the French National Research Agency (ANR)